

 KM BETA

# Cenník

Platnosť od 1.9.2024



KM BETA

## O spoločnosti KM Beta

Vyrábame pre vás strešnú krytinu, murovacie bloky, stropné systémy a suché maltové zmesi - jednoducho materiál pre celú hrubú stavbu. Nezabúdame ani na tých, ktorí si chcú výstavbu uľahčiť, pre nich vyrábame tehlové steny pre rýchlu stavbu. Tým, že pôsobíme vo všetkých regiónoch, môžeme odporučiť miestneho murára, pokrývača, projektanta. Naše produkty nájdete na mnohých predajných miestach. Najbližšiu predajňu, v ktorej je tovar na sklade, vám odporučí náš regionálny manažér.

### Poskytujeme:

- ✓ Nezáväznú kalkuláciu materiálu
- ✓ Poradenstvo
- ✓ Dopravu zdarma po celej SR
- ✓ Dopravu tovaru vlastným vozidlom s hydraulickou rukou a jeho zloženie priamo na stavbe



### Kalkulácia spotreby a ceny materiálov

Uľahčíte si prípravu stavebných prác a ušetríte čas aj peniaze. S našou kalkulačkou materiálu na stránke [www.kmbeta.sk/kalkulacky](http://www.kmbeta.sk/kalkulacky) si cenu spočítate na 3 kliknutia.

## Strešná krytina

Našu strešnú krytinu vyrábame v povrchových úpravách Prima, Samet, Briliant, Elegant a vo farbách tehlová (CI), hnedá (HN), višňová (VI), čierna (CE), šedá (SE), modrá (MO) a zelená (ZE).

Môžete si tak vybrať podľa svojho vkusu a charakteru vašej stavby.

**50 rokov  
záruka**

na betónovú  
strešnú krytinu

**15 rokov  
záruka**  
na strešný  
systém

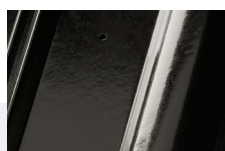

**Prima (P)**  
extra lesklá

Vytvára vysoko hladký a lesklý povrch s efektom glazúry, dodáva väčšiu odolnosť a dlhú životnosť.

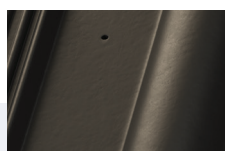

**Samet (S)**  
hladká a matná

Vytvára hladký povrch, dodáva krytine väčšiu odolnosť.



**Briliant (B)**  
lesklá

Dodáva strešnej krytine trblietanie vďaka aplikácii špeciálneho lesklého nástreku.

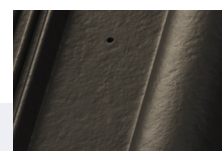

**Elegant (E)**  
matná

Dobre zapadne do tradičnej zástavby.



**Beta**

Prima CI HN VI CE

Samet CI HN VI CE

Briliant CI HN VI CE SE

Elegant CI HN VI CE SE MO\* ZE\*

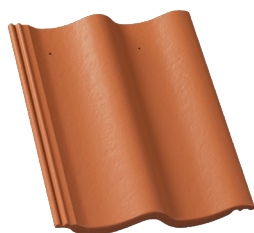

**Hodonka**

Briliant CI HN VI CE

Elegant CI HN VI CE



**Rota**

Prima CE

Briliant CE



Pre uplatnenie záruky 50 rokov zašlite do 3 mesiacov od polozenia krytiny vyplnený registračný formulár. Najneskôr však 12 mesiacov od termínu dodania krytiny.

Formulár nájdete na webovej stránke [www.kmbeta.sk](http://www.kmbeta.sk).

Pre ľahšie vyhľadanie môžete naskenovať QR kód.

\* Modré a zelené škridly (Beta Elegant) sú iba na objednávku – cena je na vyžiadanie. Vopred sa platí záloha 50%. Plastové doplnkové škridly nie sú k dispozícii.

# Strešná krytina

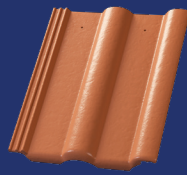

Beta

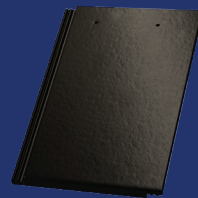

Rota

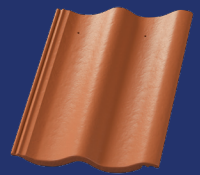

Hodonka

	Názov/ Kód výrobku	bal ks/ pal	Prima		Samet		Briliant		Elegant		bal ks/ pal	Prima		Briliant		bal ks/ pal	Briliant		Elegant	
			bez DPH/ ks	s DPH/ ks	bez DPH/ ks	s DPH/ ks	bez DPH/ ks	s DPH/ ks	bez DPH/ ks	s DPH/ ks		bez DPH/ ks	s DPH/ ks	bez DPH/ ks	s DPH/ ks		bez DPH/ ks	s DPH/ ks	bez DPH/ ks	s DPH/ ks
Základné strešné škridle	Škridla základná / <b>TZ</b>	252	<b>1,63</b>	<b>1,95</b>	<b>1,55</b>	<b>1,86</b>	<b>1,37</b>	<b>1,64</b>	<b>1,26</b>	<b>1,51</b>	180	<b>2,52</b>	<b>3,02</b>	<b>2,15</b>	<b>2,58</b>	240	<b>1,37</b>	<b>1,64</b>	<b>1,26</b>	<b>1,51</b>
	Škridla polovičná / <b>TP</b>	160	<b>2,02</b>	<b>2,42</b>	<b>1,98</b>	<b>2,38</b>	<b>1,74</b>	<b>2,08</b>	<b>1,57</b>	<b>1,88</b>	120	<b>2,91</b>	<b>3,49</b>	<b>2,58</b>	<b>3,09</b>	160	<b>1,74</b>	<b>2,08</b>	<b>1,57</b>	<b>1,88</b>
Štitová hrana	Škridla okrajová																			
	- ľavá / <b>TOL</b>	32	<b>5,66</b>	<b>6,79</b>	<b>5,56</b>	<b>6,67</b>	<b>5,26</b>	<b>6,32</b>	<b>5,04</b>	<b>6,05</b>	32	<b>9,26</b>	<b>11,11</b>	<b>9,02</b>	<b>10,82</b>	32	<b>5,26</b>	<b>6,32</b>	<b>5,04</b>	<b>6,05</b>
	- pravá / <b>TOP</b>	32	<b>5,66</b>	<b>6,79</b>	<b>5,56</b>	<b>6,67</b>	<b>5,26</b>	<b>6,32</b>	<b>5,04</b>	<b>6,05</b>	32	<b>9,26</b>	<b>11,11</b>	<b>9,02</b>	<b>10,82</b>	32	<b>5,26</b>	<b>6,32</b>	<b>5,04</b>	<b>6,05</b>
	- ľavá polovičná / <b>TOLP</b>	-	-	-	-	-	-	-	-	-	48	<b>9,50</b>	<b>11,40</b>	<b>9,26</b>	<b>11,11</b>	-	-	-	-	-
- pravá polovičná / <b>TOPP</b>	-	-	-	-	-	-	-	-	-	48	<b>9,50</b>	<b>11,40</b>	<b>9,26</b>	<b>11,11</b>	-	-	-	-	-	
Vetranie	Škridla vetracia / <b>TV</b>	36	<b>9,26</b>	<b>11,11</b>	<b>9,10</b>	<b>10,92</b>	<b>8,87</b>	<b>10,64</b>	<b>8,60</b>	<b>10,32</b>	32	<b>14,04</b>	<b>16,85</b>	<b>13,53</b>	<b>16,24</b>	36	<b>8,87</b>	<b>10,64</b>	<b>8,60</b>	<b>10,32</b>
Zábrany proti snehu	Škridla protisnehová / <b>TS</b>	54	<b>3,33</b>	<b>3,99</b>	<b>3,27</b>	<b>3,92</b>	<b>3,19</b>	<b>3,83</b>	<b>3,06</b>	<b>3,67</b>	90	<b>4,44</b>	<b>5,32</b>	<b>4,39</b>	<b>5,27</b>	54	<b>3,19</b>	<b>3,83</b>	<b>3,06</b>	<b>3,67</b>
	Škridla sneholamu kovová / <b>TSK</b>	-	<b>49,22</b>	<b>59,07</b>	<b>43,95</b>	<b>52,74</b>	<b>49,22</b>	<b>59,07</b>	<b>49,22</b>	<b>59,07</b>	-	-	-	-	-	-	<b>49,22</b>	<b>59,07</b>	<b>49,22</b>	<b>59,07</b>
Nášlapy	Škridla nášlapná / <b>TN</b>	16	<b>10,42</b>	<b>12,50</b>	<b>10,23</b>	<b>12,28</b>	<b>9,87</b>	<b>11,84</b>	<b>9,33</b>	<b>11,20</b>	18	<b>16,13</b>	<b>19,35</b>	<b>14,87</b>	<b>17,85</b>	16	<b>9,87</b>	<b>11,84</b>	<b>9,33</b>	<b>11,20</b>
Strešné prestupy	Škridla prestupová / <b>TPR</b>	16	<b>8,25</b>	<b>9,91</b>	<b>8,11</b>	<b>9,73</b>	<b>7,84</b>	<b>9,41</b>	<b>7,44</b>	<b>8,92</b>	-	-	-	-	-	30	<b>7,84</b>	<b>9,41</b>	<b>7,44</b>	<b>8,92</b>
	Škr. betónová anténa / <b>TBA</b>	-	<b>41,04</b>	<b>49,24</b>	<b>40,30</b>	<b>48,36</b>	<b>39,09</b>	<b>46,91</b>	<b>37,33</b>	<b>44,80</b>	-	<b>52,00</b>	<b>62,40</b>	<b>49,84</b>	<b>59,81</b>	-	<b>39,09</b>	<b>46,91</b>	<b>37,33</b>	<b>44,80</b>
	Škr. oddymenia turbokotla / <b>TOT</b>	-	<b>49,56</b>	<b>59,47</b>	<b>48,68</b>	<b>58,41</b>	<b>47,20</b>	<b>56,64</b>	<b>45,04</b>	<b>54,04</b>	-	<b>60,96</b>	<b>73,15</b>	<b>58,42</b>	<b>70,10</b>	-	<b>47,20</b>	<b>56,64</b>	<b>45,04</b>	<b>54,04</b>
	Škr. beton. odvetrávacia komplet																			
	- Ø 110 mm / <b>TBO110</b>	-	<b>71,34</b>	<b>85,61</b>	<b>70,07</b>	<b>84,08</b>	<b>67,96</b>	<b>81,55</b>	<b>64,71</b>	<b>77,66</b>	-	<b>93,06</b>	<b>111,67</b>	<b>89,19</b>	<b>107,02</b>	-	<b>67,96</b>	<b>81,55</b>	<b>64,71</b>	<b>77,66</b>
	- Ø 150 mm / <b>TBO150</b>	-	<b>157,74</b>	<b>189,29</b>	<b>154,92</b>	<b>185,91</b>	<b>148,82</b>	<b>178,58</b>	<b>140,39</b>	<b>168,47</b>	-	-	-	-	-	-	-	-	-	-
	Škr. káblových prestupov / <b>TKP</b>	-	<b>35,43</b>	<b>42,51</b>	<b>34,79</b>	<b>41,75</b>	<b>33,75</b>	<b>40,49</b>	<b>26,78</b>	<b>32,14</b>	-	-	-	-	-	-	-	-	-	-
Škridla hadicových prestupov / <b>THP</b>	-	<b>36,92</b>	<b>44,30</b>	<b>36,26</b>	<b>43,51</b>	<b>35,17</b>	<b>42,20</b>	<b>27,45</b>	<b>32,94</b>	-	-	-	-	-	-	-	-	-	-	
Hromozvod a kolektor	Škridla hromozvodová / <b>THS</b>	18	<b>13,18</b>	<b>15,82</b>	<b>12,95</b>	<b>15,54</b>	<b>12,51</b>	<b>15,01</b>	<b>11,97</b>	<b>14,37</b>	18	<b>16,08</b>	<b>19,30</b>	<b>15,42</b>	<b>18,51</b>	18	<b>12,51</b>	<b>15,01</b>	<b>11,97</b>	<b>14,37</b>
	Škridla kolektorová / <b>TK</b>	42	<b>9,60</b>	<b>11,52</b>	<b>9,43</b>	<b>11,31</b>	<b>9,13</b>	<b>10,95</b>	<b>8,04</b>	<b>9,65</b>	-	-	-	-	-	42	<b>9,13</b>	<b>10,95</b>	<b>8,04</b>	<b>9,65</b>
Pultová hrana	Škridla pultová																			
	- základná / <b>TPZ</b>	16	<b>12,58</b>	<b>15,09</b>	<b>12,35</b>	<b>14,82</b>	<b>11,69</b>	<b>14,03</b>	<b>11,09</b>	<b>13,31</b>	16	<b>18,35</b>	<b>22,01</b>	<b>17,58</b>	<b>21,10</b>	16	<b>11,69</b>	<b>14,03</b>	<b>11,09</b>	<b>13,31</b>
	- polovičná / <b>TPP</b>	24	<b>12,98</b>	<b>15,58</b>	<b>12,75</b>	<b>15,30</b>	<b>12,11</b>	<b>14,53</b>	<b>11,49</b>	<b>13,79</b>	16	<b>18,63</b>	<b>22,35</b>	<b>17,85</b>	<b>21,42</b>	24	<b>12,11</b>	<b>14,53</b>	<b>11,49</b>	<b>13,79</b>
	- okrajová ľavá / <b>TLOL</b>	-	<b>14,74</b>	<b>17,69</b>	<b>14,48</b>	<b>17,37</b>	<b>14,07</b>	<b>16,88</b>	<b>13,38</b>	<b>16,06</b>	16	<b>30,64</b>	<b>36,77</b>	<b>29,36</b>	<b>35,23</b>	-	<b>14,07</b>	<b>16,88</b>	<b>13,38</b>	<b>16,06</b>
	- okrajová pravá / <b>TLOP</b>	-	<b>14,74</b>	<b>17,69</b>	<b>14,48</b>	<b>17,37</b>	<b>14,07</b>	<b>16,88</b>	<b>13,38</b>	<b>16,06</b>	16	<b>30,64</b>	<b>36,77</b>	<b>29,36</b>	<b>35,23</b>	-	<b>14,07</b>	<b>16,88</b>	<b>13,38</b>	<b>16,06</b>
	- okrajová ľavá polovičná / <b>TPOLP</b>	-	-	-	-	-	-	-	-	-	48	<b>34,54</b>	<b>41,45</b>	<b>32,05</b>	<b>38,47</b>	-	-	-	-	-
	- okrajová pravá polovičná / <b>TPOLP</b>	-	-	-	-	-	-	-	-	-	48	<b>34,54</b>	<b>41,45</b>	<b>32,05</b>	<b>38,47</b>	-	-	-	-	-
Hrebeňový tesniaci prvok / <b>HTP</b>	-	<b>1,69</b>	<b>2,03</b>	<b>1,66</b>	<b>1,99</b>	<b>1,61</b>	<b>1,94</b>	<b>1,49</b>	<b>1,79</b>	-	-	-	-	-	-	<b>1,61</b>	<b>1,94</b>	<b>1,49</b>	<b>1,79</b>	
Manzardová a úžľabná hrana**	Škridla lomená																			
	- základná / <b>TLZ</b>	-	<b>10,48</b>	<b>12,58</b>	<b>10,30</b>	<b>12,36</b>	<b>9,95</b>	<b>11,93</b>	<b>9,46</b>	<b>11,36</b>	-	-	-	-	-	-	<b>9,95</b>	<b>11,93</b>	<b>9,46</b>	<b>11,36</b>
	- polovičná / <b>TLP</b>	-	<b>10,75</b>	<b>12,90</b>	<b>10,56</b>	<b>12,67</b>	<b>10,21</b>	<b>12,26</b>	<b>9,73</b>	<b>11,68</b>	-	-	-	-	-	-	<b>10,21</b>	<b>12,26</b>	<b>9,73</b>	<b>11,68</b>
	- okrajová ľavá / <b>TLOL</b>	-	<b>20,76</b>	<b>24,92</b>	<b>20,39</b>	<b>24,47</b>	<b>19,75</b>	<b>23,69</b>	<b>18,79</b>	<b>22,55</b>	-	-	-	-	-	-	<b>19,75</b>	<b>23,69</b>	<b>18,79</b>	<b>22,55</b>
	- okrajová pravá / <b>TLOP</b>	-	<b>20,76</b>	<b>24,92</b>	<b>20,39</b>	<b>24,47</b>	<b>19,75</b>	<b>23,69</b>	<b>18,79</b>	<b>22,55</b>	-	-	-	-	-	-	<b>19,75</b>	<b>23,69</b>	<b>18,79</b>	<b>22,55</b>
	Škridla úžľabná																			
	- základná / <b>TUZ</b>	-	<b>10,48</b>	<b>12,58</b>	<b>10,30</b>	<b>12,36</b>	<b>9,95</b>	<b>11,93</b>	<b>9,46</b>	<b>11,36</b>	-	-	-	-	-	-	<b>9,95</b>	<b>11,93</b>	<b>9,46</b>	<b>11,36</b>
	- polovičná / <b>TUP</b>	-	<b>10,75</b>	<b>12,90</b>	<b>10,56</b>	<b>12,67</b>	<b>10,21</b>	<b>12,26</b>	<b>9,73</b>	<b>11,68</b>	-	-	-	-	-	-	<b>10,21</b>	<b>12,26</b>	<b>9,73</b>	<b>11,68</b>
- okrajová ľavá / <b>TUOL</b>	-	<b>20,76</b>	<b>24,92</b>	<b>20,39</b>	<b>24,47</b>	<b>19,75</b>	<b>23,69</b>	<b>18,79</b>	<b>22,55</b>	-	-	-	-	-	-	<b>19,75</b>	<b>23,69</b>	<b>18,79</b>	<b>22,55</b>	
- okrajová pravá / <b>TUOP</b>	-	<b>20,76</b>	<b>24,92</b>	<b>20,39</b>	<b>24,47</b>	<b>19,75</b>	<b>23,69</b>	<b>18,79</b>	<b>22,55</b>	-	-	-	-	-	-	<b>19,75</b>	<b>23,69</b>	<b>18,79</b>	<b>22,55</b>	
Plastové strešné škridle	Škridla plastová																			
	- anténa / <b>TPA</b>	-	<b>89,60</b>	<b>107,52</b>	<b>89,60</b>	<b>107,52</b>	<b>89,60</b>	<b>107,52</b>	<b>89,60</b>	<b>107,52</b>	-	-	-	-	-	-	<b>89,60</b>	<b>107,52</b>	<b>89,60</b>	<b>107,52</b>
	- odvetrávacia Ø 110 mm / <b>TPO110</b>	-	-	-	-	-	-	-	-	-	-	-	-	-	-	-	<b>145,60</b>	<b>174,72</b>	<b>145,60</b>	<b>174,72</b>
	- odvetrávacia Ø 125 mm / <b>TPO125</b>	-	<b>145,60</b>	<b>174,72</b>	<b>145,60</b>	<b>174,72</b>	<b>145,60</b>	<b>174,72</b>	<b>145,60</b>	<b>174,72</b>	-	-	-	-	-	-	-	-	-	-
	- odvetrávacia Ø 160 mm / <b>TPO160</b>	-	<b>156,80</b>	<b>188,16</b>	<b>156,80</b>	<b>188,16</b>	<b>156,80</b>	<b>188,16</b>	<b>156,80</b>	<b>188,16</b>	-	-	-	-	-	-	-	-	-	-
	- presvetlovacia / <b>TPLP</b>	-	<b>18,94</b>	<b>22,73</b>	<b>18,94</b>	<b>22,73</b>	<b>18,94</b>	<b>22,73</b>	<b>18,94</b>	<b>22,73</b>	-	-	-	-	-	-	<b>18,94</b>	<b>22,73</b>	<b>18,94</b>	<b>22,73</b>
- konzolová / <b>TPKL</b>	-	<b>48,00</b>	<b>57,60</b>	<b>48,00</b>	<b>57,60</b>	<b>48,00</b>	<b>57,60</b>	<b>48,00</b>	<b>57,60</b>	-	-	-	-	-	-	-	-	-	-	

Názov/ Kód výrobku	ks/ pal	Prima		Samet		Briliant		Elegant	
		bez DPH/ks	s DPH/ks	bez DPH/ks	s DPH/ks	bez DPH/ks	s DPH/ks	bez DPH/ks	s DPH/ks
Hrebenáč / <b>H</b>	114	<b>3,47</b>	<b>4,17</b>	<b>3,41</b>	<b>4,09</b>	<b>3,19</b>	<b>3,83</b>	<b>2,91</b>	<b>3,49</b>
Hrebenáč krížový									
- X / <b>HKX</b>		<b>17,38</b>	<b>20,86</b>	<b>17,07</b>	<b>20,49</b>	<b>16,56</b>	<b>19,88</b>	<b>15,14</b>	<b>18,17</b>
- Y / <b>HKY</b>	30	<b>17,38</b>	<b>20,86</b>	<b>17,07</b>	<b>20,49</b>	<b>16,56</b>	<b>19,88</b>	<b>15,14</b>	<b>18,17</b>
- T / <b>HKT</b>		<b>17,38</b>	<b>20,86</b>	<b>17,07</b>	<b>20,49</b>	<b>16,56</b>	<b>19,88</b>	<b>15,14</b>	<b>18,17</b>
- XB / <b>HKXB</b>		<b>17,38</b>	<b>20,86</b>	<b>17,07</b>	<b>20,49</b>	<b>16,56</b>	<b>19,88</b>	<b>15,14</b>	<b>18,17</b>
Hreb. hromozvodový / <b>HH</b>	48	<b>9,73</b>	<b>11,68</b>	<b>9,56</b>	<b>11,47</b>	<b>9,26</b>	<b>11,11</b>	<b>8,86</b>	<b>10,63</b>
Hrebenáč koncový									
- hladký / <b>HK</b>	80	<b>10,70</b>	<b>12,84</b>	<b>10,51</b>	<b>12,61</b>	<b>10,01</b>	<b>12,02</b>	<b>9,46</b>	<b>11,36</b>
- lev / <b>HKL</b>		<b>25,29</b>	<b>30,35</b>	<b>24,84</b>	<b>29,81</b>	<b>24,07</b>	<b>28,88</b>	<b>22,93</b>	<b>27,51</b>
- vietor / <b>HKV</b>		<b>25,29</b>	<b>30,35</b>	<b>24,84</b>	<b>29,81</b>	<b>24,07</b>	<b>28,88</b>	<b>22,93</b>	<b>27,51</b>
Hrebeňová upchávka									
- slnečnica / <b>HUS</b>		<b>9,95</b>	<b>11,93</b>	<b>9,77</b>	<b>11,72</b>	<b>9,46</b>	<b>11,36</b>	<b>9,06</b>	<b>10,87</b>
- holubica / <b>HUHO</b>		<b>9,95</b>	<b>11,93</b>	<b>9,77</b>	<b>11,72</b>	<b>9,46</b>	<b>11,36</b>	<b>9,06</b>	<b>10,87</b>
- hladká / <b>HUH</b>		<b>9,53</b>	<b>11,44</b>	<b>9,36</b>	<b>11,23</b>	<b>9,06</b>	<b>10,87</b>	<b>8,72</b>	<b>10,47</b>
- slnko / <b>HUSL</b>		<b>9,95</b>	<b>11,93</b>	<b>9,77</b>	<b>11,72</b>	<b>9,46</b>	<b>11,36</b>	<b>9,06</b>	<b>10,87</b>
- hrozno / <b>HUHR</b>		<b>9,95</b>	<b>11,93</b>	<b>9,77</b>	<b>11,72</b>	<b>9,46</b>	<b>11,36</b>	<b>9,06</b>	<b>10,87</b>
- plastová / <b>HU</b>		<b>1,83</b>	<b>2,19</b>	<b>1,79</b>	<b>2,15</b>	<b>1,83</b>	<b>2,19</b>	<b>1,83</b>	<b>2,19</b>
Hrebeňový okrasný prvok									
- vežička / <b>HOPV</b>		<b>73,84</b>	<b>88,61</b>	<b>72,52</b>	<b>87,03</b>	<b>70,32</b>	<b>84,39</b>	<b>64,78</b>	<b>77,74</b>
- hrdličky / <b>HOPH</b>		<b>73,84</b>	<b>88,61</b>	<b>72,52</b>	<b>87,03</b>	<b>70,32</b>	<b>84,39</b>	<b>64,78</b>	<b>77,74</b>
- kohút / <b>HOPK</b>		<b>73,84</b>	<b>88,61</b>	<b>72,52</b>	<b>87,03</b>	<b>70,32</b>	<b>84,39</b>	<b>64,78</b>	<b>77,74</b>

Názov/ Kód výrobku	Balenie	mj	bez DPH/mj	s DPH/mj
Príchytka hrebenáča / <b>PH</b>	50 ks v balení	1 ks	<b>0,36</b>	<b>0,43</b>
Držiak hrebeňovej laty (vnútorná šírka 35 mm) * / <b>PHL</b>	-	1 ks	<b>1,51</b>	<b>1,81</b>
Držiak hrebeňovej laty s klincom (vnútorná šírka 40 mm) / <b>DHLH</b>	-	1 ks	<b>1,51</b>	<b>1,81</b>
Univerzálny držiak hrebeňovej a nárožnej laty (vnútorná šírka 30mm) / <b>UDHNL</b>	-	1 ks	<b>1,63</b>	<b>1,96</b>
Univerzálny pás				
- Al Rol celohliníkový / <b>UPAR</b>	5bm rolka	1 bm	<b>11,83</b>	<b>14,20</b>
- textilný / <b>UP</b>	5bm rolka	1 bm	<b>8,81</b>	<b>10,58</b>
- Beta Rol celomedený / <b>UPBR</b>	5bm rolka	1 bm	<b>18,06</b>	<b>21,67</b>
Prítlačný valček * / <b>PV</b>	-	1 ks	<b>5,80</b>	<b>6,96</b>
Kefová lišta univerzálna / <b>KLU</b>	-	1 ks	<b>9,54</b>	<b>11,45</b>

Pás úžľabia so stredovou drážkou				
- medený / <b>MPU</b>	2 bm v balení	1 ks	<b>155,25</b>	<b>186,30</b>
- hliníkový / <b>HPU</b>	2 bm v balení	1 ks	<b>30,13</b>	<b>36,16</b>
Tesniaca lišta úžľabia / <b>TLU</b>	200ks/krabica	1 ks	<b>1,85</b>	<b>2,22</b>
Tesniaci pás úžľabia <b>TPU</b>		1 ks	<b>10,75</b>	<b>12,90</b>

Ochranná vetracia mriežka				
- jednoduchá / <b>OVMJ</b>	50 ks v balení	1 ks	<b>1,27</b>	<b>1,52</b>
- univerzál / <b>OVMU</b>	50 ks v balení	1 ks	<b>3,02</b>	<b>3,63</b>
Ochranný pás proti vtákom				
- šírka 50 mm * / <b>OP50</b>	5 bm rolka	1 bm	<b>1,15</b>	<b>1,38</b>
- šírka 80 mm / <b>OP80</b>	5 bm rolka	1 bm	<b>1,27</b>	<b>1,52</b>
- šírka 100 mm / <b>OP100</b>	5 bm rolka	1 bm	<b>1,33</b>	<b>1,59</b>

Katologové označenie:

**B - P - CE - TZ**

B - Beta  
R - Rota  
H - Hodonka  
S - Strešné doplnky a príslušenstvo

P - Prima  
S - Samet  
B - Brilliant  
E - Elegant

CE - čierna  
CI - tehlová  
SE - šedá  
ZE - zelená





TZ - škrídla základná  
TS - škrídla protisnehová  
H - hrebenáč apod.

VI - višňová  
HN - hnedá  
MO - modrá

Názov/ Kód výrobku	Balenie	mj	bez DPH/mj	s DPH/mj
Nášlapný rošt vrátane držiakov				
- 600 mm / <b>NRM</b>	-	1 ks	<b>65,02</b>	<b>78,02</b>
- 800 mm / <b>NRV</b>	-	1 ks	<b>82,27</b>	<b>98,72</b>
Nášlap škridle vrátane držiaku / <b>NT</b>	-	1 ks	<b>28,26</b>	<b>33,91</b>
Vzpera plošiny univerzálna / <b>VPU</b>	-	1 ks	<b>19,08</b>	<b>22,89</b>
Protisnehová zábrana / <b>PZ</b>	-	1 ks	<b>1,80</b>	<b>2,16</b>
Mreža sneholamu zosilnená s nitovaním 1800 x 200 mm / <b>MS</b>	-	1 ks	<b>45,89</b>	<b>55,06</b>
Vzpera mreže sneholamu / <b>VMS</b>	-	1 ks	<b>12,56</b>	<b>15,07</b>
Hák na drevenú guľatinu / <b>HDK</b>	-	1 ks	<b>24,15</b>	<b>28,98</b>
Strešné okná				
Strešné okno výstupné				
- Beta 450 x 730 mm / <b>SOVBV</b>	-	1 ks	<b>260,00</b>	<b>312,00</b>
- Beta 460 x 510 mm * / <b>SOVBM</b>	-	1 ks	<b>180,00</b>	<b>216,00</b>
Strešné okno kovové				
- Beta 500 x 600 mm / <b>SOVBK</b>	-	1 ks	<b>185,00</b>	<b>222,00</b>
- Hodonka 500 x 600 mm / <b>SOVHK</b>	-	1 ks	<b>185,00</b>	<b>222,00</b>
- Rota 600 x 600 mm / <b>SOVRK</b>	-	1 ks	<b>180,00</b>	<b>216,00</b>
Strešné prestupy				
Plastové viečko / <b>PLV</b>	-	1 ks	<b>1,33</b>	<b>1,59</b>
Hydroizolačný prestupový krúžok				
- Ø 110 mm / <b>HPK</b>	-	1 ks	<b>3,80</b>	<b>4,56</b>
- Ø 150 mm / <b>HPK150</b>	-	1 ks	<b>4,00</b>	<b>4,80</b>
Fólie a pásy				
Hydroizolačné fólie				
- KM BETA 150 s aplikačnou páskou / <b>HF150TT</b>	50 bm / 75 m <sup>2</sup> rolka	1m <sup>2</sup>	<b>2,13</b>	<b>2,55</b>
- JUTADACH - 135 2AP s aplikačnou páskou / <b>HF1352AP</b>	50 bm / 75 m <sup>2</sup> rolka	1m <sup>2</sup>	<b>3,22</b>	<b>3,86</b>
- JUTADACH - 150 2AP s aplikačnou páskou / <b>HF1502AP</b>	50 bm / 75 m <sup>2</sup> rolka	1m <sup>2</sup>	<b>3,50</b>	<b>4,20</b>
- DELTA - MAXX PLUS / <b>HFDMP</b>	50 bm / 75 m <sup>2</sup> rolka	1m <sup>2</sup>	<b>4,71</b>	<b>5,65</b>
- DELTA FOX - PLUS / <b>HFDFFP</b>	50 bm / 75 m <sup>2</sup> rolka	1m <sup>2</sup>	<b>6,89</b>	<b>8,27</b>
DELTA - HF PRIMER / <b>DHP</b>	1 l / fľaša	1 ks	<b>34,80</b>	<b>41,76</b>
Lepidlo DELTA THAN / <b>LDT</b>	310 ml / kartuša	1 ks	<b>19,85</b>	<b>23,82</b>
Lepiaci páska DELTA - MULTI - BAND	25 bm/rolka	1rol	<b>28,26</b>	<b>33,91</b>
Tesniaca páska				
- DELTA FLEXX - BAND / <b>TPDFB</b>	10 bm / rolka	1rol	<b>52,74</b>	<b>63,29</b>
- DELTA SB 60 / <b>TPNDB</b>	30 bm / rolka	1bm	<b>1,03</b>	<b>1,23</b>
Samolepiaci pás na fólie / <b>SPF</b>	25 bm / rolka	1bm	<b>1,27</b>	<b>1,52</b>
Butylkaučuková lepiaca páska / <b>BLP</b>	rolka	1bm	<b>0,91</b>	<b>1,09</b>
Odkvapový plech				
- hliníkový / <b>HOP</b>	2 bm	1ks	<b>18,40</b>	<b>22,08</b>
- medený / <b>MOP</b>	2 bm	1 ks	<b>62,10</b>	<b>74,52</b>
Lemovací pás / <b>LP</b>	5 bm / rolka	1bm	<b>22,20</b>	<b>26,63</b>
Krycia lišta lemovacího pásu / <b>KLLP</b>	-	1 ks	<b>11,96</b>	<b>14,35</b>
Spojovací materiál a palety				
Adaptér pre vodorovné vedenie bleskozvodu / <b>AVVH</b>	-	1 ks	<b>3,01</b>	<b>3,62</b>
Príchytka škridle / <b>PT</b>	-	1 ks	<b>0,30</b>	<b>0,36</b>
Paleta 120x80	-	1 ks	<b>16,00</b>	<b>19,20</b>
Paleta 100x120	-	1 ks	<b>16,00</b>	<b>19,20</b>
Vykládka hydraulickou rukou	-	1 ks	<b>6,00</b>	<b>7,20</b>

\* len dopredaj tovaru \*\*vopred sa platí záloha 50%

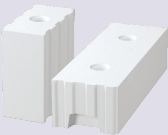
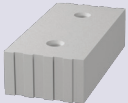
# Prehľad prvkov Sendwix

Kategórie	290 mm	240 mm	200 mm	175 mm	150 mm	115 mm	
Murovacie bloky	 - modulová dĺžka 500 mm	-	SND-16DF-LDE SND-16DF-LPE	SND-14DF-LDE SND-14DF-LP	SND-12DF-LDE SND-12DF-LDZE SND-12DF-LDZHE	SND-10DF-LPE	-
	 - modulová dĺžka 250 mm	-	SND-8DF-LDE SND-8DF-LP-AKU	SND-7DF-LDE SND-7DF-LP	SND-6DF-LDE SND-6DF-LDZE SND-6DF-LDZHE	-	SND-4DF-LDE
Doplnkové bloky		SND-5DF-LP	SND-5DF-LP SND-2DF-LD SND-1/2 8DF-LPE	SND-1/2-14DF-LDE	SND-1/2-12DF-LDE	SND-1/2-10DF-LPE	SND-2DF-LD
Tepelnoizolačné bloky (Thermly)		SND-4DF-D-THERM + SND-12DF-D-THERM	SND-16DF-D-THERM	SND-14DF-D-THERM	SND-12DF-D-THERM	SND-10DF-D-THERM	SND-4DF-D-THERM
Vencovky		-	SND-8DF-U	SND-7DF-U	SND-6DF-U	SND-5DF-U	SND-2DF-U
Preklady		SND-2DF + SND-6DF	SND-8DF (nebo 2 x SND-2DF)	SND-7DF	SND-6DF	SND-5DF	SND-2DF
Spotreba lepidla	- pre modulovú výšku 250 mm (kg/m <sup>2</sup> muriva)  - pre modulovú výšku 125 mm (kg/m <sup>2</sup> muriva)*	12,3*	4,0	3,6	3,0	2,6	2,0

## Katalógové označenie:

SND - obchodný názov vápenopieskových blokov

# SND - 8DF - LDE (P, U, Z, H)

8DF - označenie formátu

E - elektrokanáliky

L - výrobok pro tenkovrstvové murovanie na lepidlo

D - dierovaný formát

P - plný formát  
U - U profil  
Z - skosená pohľadová hrana  
H - hladká styčná plocha

## Murovacie bloky



Názov/ Katalógové označenie	Hrúbka steny	Balenie ks/pal	Rozmer (mm) d x š x v	Hmotnosť kg/ks	Spotreba ks/m <sup>2</sup>	Spotreba ks/m <sup>3</sup>	Cena bez DPH/ks	Cena bez DPH/m <sup>2</sup>	Cena s DPH/ks	Cena s DPH/m <sup>2</sup>
Sendwix 5DF-LP / <b>SND-5DF-LP</b>	290 / 240	72	290 × 240 × 123	15,7	33 / 27	112 / 110	1,62	53,35	1,94	64,02
Sendwix 2DF-LD / <b>SND-2DF-LD</b>	240 / 115	196	240 × 115 × 123	6,2	65 / 33	283 / 271	0,81	52,54	0,97	63,05
Sendwix 16DF-LDE / <b>SND-16DF-LDE</b>	240 mm	24	498 × 240 × 248	37,2	8,0	33,5	5,60	44,83	6,72	53,80
Sendwix 16DF-LDE / <b>SND-16DF-LPE</b>		24	498 × 240 × 248	57,5	8,0	33,5	6,16	49,32	7,40	59,18
Sendwix 8DF-LDE / <b>SND-8DF-LDE</b>		48	248 × 240 × 248	19,8	16,0	67,0	2,80	44,83	3,36	53,80
Sendwix 8DF-LP AKU / <b>SND-8DF-LP-AKU</b>		48	248 × 240 × 248	27,0	16,0	67,0	3,02	48,28	3,62	57,94
Sendwix 1/2 8DF-LPE / <b>SND-1/2-8DF-LPE</b>		64	123 × 240 × 248	14,2	32,0	134,0	3,13	100,01	3,75	120,01
Sendwix 14DF-LDE / <b>SND-14DF-LDE</b>		32	498 × 200 × 248	31,8	8,0	40,0	4,74	37,94	5,69	45,52
Sendwix 14DF-LP / <b>SND-14DF-LP</b>	200 mm	24	498 × 200 × 248	48,0	8,0	40,0	5,28	42,25	6,34	50,70
Sendwix 1/2 14DF-LDE / <b>SND-1/2-14DF-LDE</b>		64	498 × 200 × 123	17,2	16,0	80,0	4,85	77,59	5,82	93,11
Sendwix 7DF-LDE / <b>SND-7DF-LDE</b>		64	248 × 200 × 248	16,9	16,0	80,0	2,48	39,66	2,97	47,59
Sendwix 7DF-LP / <b>SND-7DF-LP</b>		48	248 × 200 × 248	22,4	16,0	80,0	2,69	43,11	3,23	51,73
Sendwix 12DF-LDE / <b>SND-12DF-LDE</b>		32	498 × 175 × 248	28,1	8,0	45,7	4,20	33,62	5,04	40,35
Sendwix 12DF-LDZE / <b>SND-12DF-LDZE</b>		32	498 × 175 × 248	27,6	8,0	45,7	4,63	37,07	5,56	44,49
Sendwix 12DF-LDZHE / <b>SND-12DF-LDZHE</b>	175 mm	32	498 × 175 × 248	28,3	8,0	45,7	4,63	37,07	5,56	44,49
Sendwix 1/2 12DF-LDE / <b>SND-1/2-12DF-LDE</b>		64	498 × 175 × 123	15,2	16,0	91,4	4,15	66,39	4,98	79,66
Sendwix 6DF-LDE / <b>SND-6DF-LDE</b>		64	248 × 175 × 248	16,2	16,0	91,4	2,21	35,35	2,65	42,42
Sendwix 6DF-LDZE / <b>SND-6DF-LDZE</b>		64	248 × 175 × 248	12,4	16,0	91,4	2,37	37,94	2,85	45,52
Sendwix 6DF-LDZHE / <b>SND-6DF-LDZHE</b>		64	248 × 175 × 248	16,4	16,0	91,4	2,37	37,94	2,85	45,52
Sendwix 10DF-LPE / <b>SND-10DF-LPE</b>		150 mm	36	498 × 150 × 248	38,0	8,0	53,3	4,80	38,40	5,76
Sendwix 1/2 10DF-LPE / <b>SND-1/2-10DF-LPE</b>	72		498 × 150 × 123	18,5	16,0	106,7	4,56	72,96	5,47	87,55
Sendwix 4DF-LDE / <b>SND-4DF-LDE</b>	115 mm	84	248 × 115 × 248	11,1	16,0	139,0	1,40	22,42	1,68	26,90
Sendwix P7 / <b>SND-P7</b>	70 mm	84	498 × 70 × 240	16,5	8,0	114,3	5,10	40,78	6,12	48,94

## Thermy



Sendwix 16DF-D THERM / <b>SND-16DF-D THERM</b>	240 mm	48	498 × 240 × 113	18,2	-	-	17,53	-	21,03	-
Sendwix 14DF-D THERM / <b>SND-14DF-D THERM</b>	200 mm	60	498 × 200 × 113	15,0	-	-	16,26	-	19,51	-
Sendwix 12DF-D THERM / <b>SND-12DF-D THERM</b>	175 mm	60	498 × 175 × 113	13,0	-	-	15,00	-	18,00	-
Sendwix 10DF-D THERM / <b>SND-10DF-D THERM</b>	150 mm	72	498 × 150 × 113	11,5	-	-	13,79	-	16,55	-
Sendwix 4DF-D THERM / <b>SND-4DF-D THERM</b>	115 mm	96	498 × 115 × 113	8,3	-	-	12,47	-	14,96	-

## Vencovky





Sendwix 8DF-U / <b>SND-8DF-U</b>	240 mm	48	250 × 240 × 240	15,5	-	-	2,97	-	3,56	-
Sendwix 7DF-U / <b>SND-7DF-U</b>	200 mm	64	250 × 200 × 240	12,9	-	-	2,92	-	3,50	-
Sendwix 6DF-U / <b>SND-6DF-U</b>	175 mm	60	248 × 175 × 240	11,5	-	-	2,89	-	3,47	-
Sendwix 5DF-U / <b>SND-5DF-U</b>	150 mm	72	248 × 150 × 240	9,9	-	-	2,83	-	3,40	-
Sendwix 2DF-U / <b>SND-5DF-U</b>	115 mm	196	125 × 115 × 240	4,9	-	-	1,93	-	2,31	-

## Nosné preklady



Názov/ Katalógové označenie	Hrúbka steny	Hmot. kg/ks	Rozmer (mm) d x š x v	Balenie ks/pal	Maximálna svetlosť otvoru (mm)	Cena bez DPH/ks	Cena s DPH/ks
Preklad 8DF 1000 / <b>SND-8DF-1000</b>	240 mm	123,8	1000 × 240 × 240	12	700	37,96	45,55
Preklad 8DF 1250 / <b>SND-8DF-1250</b>		154,7	1250 × 240 × 240	12	950	45,66	54,79
Preklad 8DF 1500 / <b>SND-8DF-1500</b>		185,7	1500 × 240 × 240	12	1200	49,74	59,69
Preklad 8DF 1750 / <b>SND-8DF-1750</b>		217,4	1750 × 240 × 240	8	1450	53,36	64,03
Preklad 8DF 2000 / <b>SND-8DF-2000</b>		248,4	2000 × 240 × 240	8	1700	70,48	84,57
Preklad 8DF 2250 / <b>SND-8DF-2250</b>		279,5	2250 × 240 × 240	8	1850	79,99	95,99
Preklad 8DF 2500 / <b>SND-8DF-2500</b>		312,4	2500 × 240 × 240	7	2100	98,80	118,56
Preklad 8DF 2750 / <b>SND-8DF-2750</b>		346,0	2750 × 240 × 240	6	2250	108,43	130,11
Preklad 8DF 3000 / <b>SND-8DF-3000</b>		377,5	3000 × 240 × 240	6	2500	116,36	139,63
Preklad 7DF 1000 / <b>SND-7DF-1000</b>		90,4	1000 × 200 × 240	15	700	33,84	40,60
Preklad 7DF 1250 / <b>SND-7DF-1250</b>	113,0	1250 × 200 × 240	15	950	40,45	48,53	
Preklad 7DF 1500 / <b>SND-7DF-1500</b>	135,6	1500 × 200 × 240	10	1200	49,07	58,89	
Preklad 7DF 1750 / <b>SND-7DF-1750</b>	158,2	1750 × 200 × 240	10	1450	51,99	62,38	
Preklad 7DF 2000 / <b>SND-7DF-2000</b>	180,8	2000 × 200 × 240	10	1700	66,10	79,32	
Preklad 7DF 2250 / <b>SND-7DF-2250</b>	203,4	2250 × 200 × 240	10	1850	74,06	88,87	
Preklad 7DF 2500 / <b>SND-7DF-2500</b>	226,0	2500 × 200 × 240	8	2100	83,66	100,40	
Preklad 7DF 2750 / <b>SND-7DF-2750</b>	248,6	2750 × 200 × 240	8	2250	93,16	111,79	
Preklad 7DF 3000 / <b>SND-7DF-3000</b>	271,2	3000 × 200 × 240	7	2500	100,29	120,35	

	Názov/ Katalógové označenie	Hrúbka steny	Hmot. kg/ks	Rozmer (mm) d x š x v	Balenie ks/pal	Maximálna svetlosť otvoru (mm)	Cena bez DPH/ks	Cena s DPH/ks
<b>Nosné preklady</b>  	Preklad 6DF 1000 / <b>SND-6DF-1000</b>	175 mm	79,1	1000 × 175 × 240	15	700	<b>33,20</b>	<b>39,84</b>
	Preklad 6DF 1250 / <b>SND-6DF-1250</b>		98,4	1250 × 175 × 240	15	950	<b>39,31</b>	<b>47,18</b>
	Preklad 6DF 1500 / <b>SND-6DF-1500</b>		118,7	1500 × 175 × 240	15	1200	<b>51,33</b>	<b>61,59</b>
	Preklad 6DF 1750 / <b>SND-6DF-1750</b>		138,3	1750 × 175 × 240	12	1450	<b>54,62</b>	<b>65,54</b>
	Preklad 6DF 2000 / <b>SND-6DF-2000</b>		157,8	2000 × 175 × 240	12	1700	<b>61,18</b>	<b>73,42</b>
	Preklad 6DF 2250 / <b>SND-6DF-2250</b>		178,7	2250 × 175 × 240	10	1850	<b>70,82</b>	<b>84,98</b>
	Preklad 6DF 2500 / <b>SND-6DF-2500</b>		198,4	2500 × 175 × 240	10	2100	<b>77,84</b>	<b>93,40</b>
	Preklad 6DF 2750 / <b>SND-6DF-2750</b>		219,6	2750 × 175 × 240	10	2250	<b>88,14</b>	<b>105,77</b>
	Preklad 6DF 3000 / <b>SND-6DF-3000</b>		239,4	3000 × 175 × 240	8	2500	<b>95,51</b>	<b>114,62</b>
	Preklad 5DF 1000 / <b>SND-5DF-1000</b>		150 mm	63,8	1000 × 150 × 240	18	700	<b>32,34</b>
	Preklad 5DF 1250 / <b>SND-5DF-1250</b>	79,6		1250 × 150 × 240	18	950	<b>38,30</b>	<b>45,96</b>
	Preklad 5DF 1500 / <b>SND-5DF-1500</b>	95,9		1500 × 150 × 240	18	1200	<b>50,00</b>	<b>59,99</b>
	Preklad 5DF 1750 / <b>SND-5DF-1750</b>	112,0		1750 × 150 × 240	18	1450	<b>53,21</b>	<b>63,85</b>
	Preklad 5DF 2000 / <b>SND-5DF-2000</b>	128,0		2000 × 150 × 240	12	1700	<b>59,63</b>	<b>71,56</b>
	Preklad 5DF 2250 / <b>SND-5DF-2250</b>	145,0		2250 × 150 × 240	12	1850	<b>69,03</b>	<b>82,83</b>
	Preklad 5DF 2500 / <b>SND-5DF-2500</b>	161,0		2500 × 150 × 240	12	2100	<b>75,91</b>	<b>91,09</b>
	Preklad 5DF 2750 / <b>SND-5DF-2750</b>	177,7		2750 × 150 × 240	10	2250	<b>86,00</b>	<b>103,20</b>
	Preklad 5DF 3000 / <b>SND-5DF-3000</b>	193,8		3000 × 150 × 240	10	2500	<b>93,12</b>	<b>111,74</b>
	Preklad 2DF 1000 / <b>SND-2DF-1000</b>	115 mm		48,6	1000 × 115 × 240	32	700	<b>13,26</b>
	Preklad 2DF 1250 / <b>SND-2DF-1250</b>		60,7	1250 × 115 × 240	32	950	<b>17,57</b>	<b>21,08</b>
	Preklad 2DF 1500 / <b>SND-2DF-1500</b>		73,0	1500 × 115 × 240	24	1200	<b>19,94</b>	<b>23,93</b>
	Preklad 2DF 1750 / <b>SND-2DF-1750</b>		85,7	1750 × 115 × 240	24	1450	<b>25,61</b>	<b>30,73</b>
	Preklad 2DF 2000 / <b>SND-2DF-2000</b>		98,0	2000 × 115 × 240	16	1700	<b>33,99</b>	<b>40,79</b>
	Preklad 2DF 2250 / <b>SND-2DF-2250</b>		111,2	2250 × 115 × 240	16	1850	<b>38,41</b>	<b>46,09</b>
	Preklad 2DF 2500 / <b>SND-2DF-2500</b>		123,5	2500 × 115 × 240	16	2100	<b>48,16</b>	<b>57,79</b>
	Preklad 2DF 2750 / <b>SND-2DF-2750</b>		135,8	2750 × 115 × 240	14	2250	<b>52,69</b>	<b>63,23</b>
	Preklad 2DF 3000 / <b>SND-2DF-3000</b>		148,2	3000 × 115 × 240	14	2500	<b>58,92</b>	<b>70,70</b>

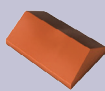
	Názov/ Katalógové označenie	Bal. ks/pal.	Rozmer (mm) d x š x v	Hmot. kg/ks	Spotreba ks/m <sup>2</sup>	Spotreba ks/m <sup>3</sup>	Cena bez DPH/ks	Cena s DPH/ks
<b>Lícové murivo</b>   	Sendwix lícová tehla VF / <b>SND-VF</b> nefarbená ●	240	<b>290 × 140 × 65</b>	4,7	<b>89 / 44 / 22</b>	<b>314 / 307 / 339</b>	<b>0,52 0,77</b> ●●	<b>0,62 0,92</b> ●●
	Sendwix lícová NF / <b>SND-NF</b> nefarbená ●	308	<b>240 × 115 × 71</b>	3,6	<b>96 / 48 / 32</b>	<b>398 / 413 / 443</b>	<b>0,46 0,66</b> ●	<b>0,55 0,79</b> ●
	Betónová hlavica							
	- hladká / <b>SND-BH-H</b> ●●●●●	32	390 x 390	15,7	-	-	cena na vyžiadanie	
	- profilovaná / <b>SND-BH-P</b> ●●●●●	32	320 x 245	6,5	-	-	cena na vyžiadanie	
	Betónová strieška							
- hladká / <b>SND-BS-H</b> ●●●●●	36	390 x 270	11,3	-	-	cena na vyžiadanie		
- profilovaná / <b>SND-BS-P</b> ●●●●●	36	497 x 245	9,3	-	-	cena na vyžiadanie		

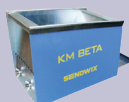
<b>Nástroje a príslušen- stvo</b>  	Zaslepovacie viečko Ø 40 mm / <b>SND-ZV</b>	1 ks	Ø 40 mm	-	-	-	<b>0,25</b>	<b>0,30</b>
	Manipulačný hák / <b>SND-MH</b>	1 ks	-	-	-	-	<b>30,00</b>	<b>36,00</b>
	Malé kliešte / <b>SND-MK</b>	1 ks	-	-	-	-	<b>131,00</b>	<b>157,20</b>
	Veľké kliešte / <b>SND-VK</b>	1 ks	-	-	-	-	<b>144,00</b>	<b>172,80</b>
	Bezfarebný prípravok na ochranu Sendwix							
	- 5 litrov / <b>SND-FH5</b>	5 l	-	-	-	-	<b>66,00</b>	<b>79,20</b>
	- 1 liter / <b>SND-FH1</b>	1 l	-	-	-	-	<b>14,00</b>	<b>16,80</b>
	Vykružovacia korunka Ø 82 mm / <b>SND-VKO</b>	1ks	dĺžka 110mm	-	-	-	<b>140,00</b>	<b>168,00</b>
	Stenová spona / <b>SND-SSP</b> (1ks spona + 2ks narážacia hmož. s vrutom 6/45)	1 ks	-	-	-	-	<b>1,96</b>	<b>2,35</b>
	Dávkovač na lepidlo * / <b>SND-DL</b>	1 ks	-	-	-	-	<b>110,00</b>	<b>132,00</b>
	Dávk. na lep. s posuvným hradítkom * / <b>SND-DLH</b>	1 ks	-	-	-	-	<b>256,00</b>	<b>307,20</b>
	Vykládka hydraulickou rukou	1 ks					<b>6,00</b>	<b>7,20</b>
	Paleta KM BETA	1 ks	120x80, 100x120	-	-	-	<b>16,00</b>	<b>19,20</b>

\* Dávkovače sú vždy iba pre jednu hrúbku steny. Hrúbku je potrebné zvoliť pri objednávke. Sú dostupné pre hrúbku steny 290 mm, 240 mm, 200 mm, 175 mm, 150 mm a 115 mm.



# Profiblok

## - pálené murivo



Murovacie bloky s lepidlom na rebrá



Murovacie bloky s murovacou penou

### Brúsené murivo

V cene je zahrnuté príslušné spojivo (lepidlo / pena)



Názov/ Katalógové označenie	Hrúbka steny	Bal. ks/pal.	Rozmer (mm) d x š x v	Hmot. kg/ks	Spotr. ks/m <sup>2</sup>	Spotr. ks/m <sup>3</sup>	Z / P			Z / P		
							Cena bez DPH/ks	Cena bez DPH/m <sup>2</sup>	Cena bez DPH/m <sup>3</sup>	Cena s DPH/ks	Cena s DPH/m <sup>2</sup>	Cena s DPH/m <sup>3</sup>
Profiblok 440 Brus / <b>PB-440-B-Z(P)</b>	440 mm	60	247 × 440 × 249	21,90	16,0	36,4	5,07	81,12	184,55	6,08	97,34	221,46
Profiblok 400 Brus / <b>PB-400-B-Z(P)</b>	400 mm	72	247 × 400 × 249	18,96	16,0	40,4	4,92	255,05	196,80	5,90	306,06	236,16
Profiblok 365 Brus / <b>PB-365-B-Z(P)</b>	365 mm	72	247 × 365 × 249	18,57	16,0	43,8	4,77	76,32	208,93	5,72	91,58	250,72
Profiblok 300 Brus / <b>PB-300-B-Z(P)</b>	300 mm	96	247 × 300 × 249	13,48	16,0	53,3	3,30	52,80	175,89	3,96	63,36	211,07
Profiblok 300 P15 Brus / <b>PB-300-B-Z(P)-P15</b>		96	247 × 300 × 249	13,48	16,0	53,3	3,52	56,32	187,62	4,22	67,58	225,14
Profiblok 300 1/2 Brus / <b>PB-1/2-300-B-Z(P)</b>		96	125 × 300 × 249	8,27	32,0	106,6	3,07	98,24	327,26	3,68	117,89	392,71
Profiblok 300 1/2 P15 Brus / <b>PB-1/2-300-B-Z(P)-P15</b>		96	125 × 300 × 249	8,27	32,0	106,6	3,30	105,60	351,78	3,96	126,72	422,14
Profiblok 240 Brus / <b>PB-240-B-Z(P)</b>	240 mm	72	372 × 240 × 249	16,16	10,7	44,4	3,90	41,73	173,16	4,68	50,08	207,79
Profiblok 240 P15 Brus / <b>PB-240-B-Z(P)-P15</b>		72	372 × 240 × 249	16,16	10,7	44,4	4,12	44,08	182,93	4,94	52,90	219,52
Profiblok 175 Brus / <b>PB-175-B-Z(P)</b>	175 mm	72	497 × 175 × 249	16,75	8,0	45,7	3,86	30,88	176,40	4,63	37,06	211,68
Profiblok 140 Brus / <b>PB-140-B-Z(P)</b>	140 mm	96	497 × 140 × 249	14,92	8,0	57,1	3,32	26,56	189,90	3,98	31,87	227,88
Profiblok 115 Brus / <b>PB-115-B-Z(P)</b>	115 mm	100	497 × 115 × 249	13,00	8,0	69,6	3,00	24,00	208,80	3,60	28,80	250,56
Profiblok 80 Brus / <b>PB-80-B-Z(P)</b>	80 mm	140	497 × 80 × 249	8,8	8,0	100,0	2,36	18,88	236,00	2,83	22,66	283,20

### Murivo na maltu

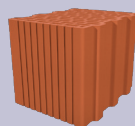

Názov/ Katalógové označenie	Hrúbka steny	Bal. ks/pal.	Rozmer (mm) d x š x v	Hmot. kg/ks	Spotr. ks/m <sup>2</sup>	Spotr. ks/m <sup>3</sup>	Cena bez DPH/ks	Cena bez DPH/m <sup>2</sup>	Cena bez DPH/m <sup>3</sup>	Cena s DPH/ks	Cena s DPH/m <sup>2</sup>	Cena s DPH/m <sup>3</sup>
Profiblok 440 / <b>PB-440</b>	440 mm	60	247 × 440 × 238	20,90	16,0	36,4	4,22	226,87	516,11	5,06	272,24	619,33
Profiblok 400 / <b>PB-400</b>	400 mm	72	247 × 400 × 238	18,10	16,0	40,0	4,07	210,99	527,47	4,88	253,19	632,96
Profiblok 365 / <b>PB-365</b>	365 mm	72	247 × 365 × 238	17,26	16,0	43,8	3,92	195,69	535,71	4,70	234,83	642,85
Profiblok 300 / <b>PB-300</b>	300 mm	96	247 × 300 × 238	12,79	16,0	53,3	2,64	42,24	140,71	3,17	50,69	168,85
Profiblok 300 AKU / <b>PB-300-AKU</b>		96	247 × 300 × 238	20,20	16	53,3						
Profiblok 300 P15 / <b>PB-300-P15</b>		96	247 × 300 × 238	12,79	16,0	53,3	2,86	45,76	152,44	3,43	54,91	182,93
Profiblok 300 1/2 / <b>PB-1/2-300</b>		96	125 × 300 × 238	8,00	32,0	53,3	2,41	77,12	256,91	2,89	92,54	308,29
Profiblok 300 1/2 P15 / <b>PB-1/2-300-P15</b>	96	125 × 300 × 238	8,00	32,0	106,6	2,64	84,48	281,42	3,17	101,38	337,70	
Profiblok 240 / <b>PB-240</b>	240 mm	72	372 × 240 × 238	15,30	10,7	44,4	3,06	32,74	135,86	3,67	39,29	163,03
Profiblok 240 P15 / <b>PB-240-P15</b>		72	372 × 240 × 238	15,30	10,7	44,4	3,29	35,20	146,08	3,95	42,24	175,30
Profiblok 175 / <b>PB-175</b>	175 mm	64	497 × 175 × 238	15,93	8,0	45,7	3,25	26,00	148,53	3,90	31,20	178,24
Profiblok 140 / <b>PB-140</b>	140 mm	80	497 × 140 × 249	14,25	8,0	57,1	2,96	23,68	169,31	3,55	28,42	203,17
Profiblok priečkovka 290 / <b>PB-290</b>		390	290 × 140 × 65	2,07	44 / 22	339 / 314	0,55	-	-	0,66	-	-
Profiblok tehla plná odlahčená VF / <b>PB-VF</b>		195	290 × 140 × 65	3,11	89 / 44	314 / 307	0,84	36,96	263,76	1,01	44,35	316,51
Profiblok 115 / <b>PB-115</b>	115 mm	96	497 × 115 × 238	12,47	8,0	69,6	2,45	19,60	170,52	2,94	23,52	204,62
Profiblok 115 AKU / <b>PB-115-AKU</b>		96	497 × 115 × 238	14,26	8,0	69,6	3,16	25,28	219,94	3,79	30,34	263,93
Profiblok tehla plná odlahčená NF / <b>PB-NF</b>		364	240 × 115 × 71	2,78	96 / 47	413 / 398	0,69	33,12	284,97	0,83	39,74	341,96
Profiblok 80 / <b>PB-80</b>	80 mm	96	497 × 80 × 238	8,53	8,0	100,0	1,95	15,60	195,00	2,34	18,72	234,00

### Vencovky

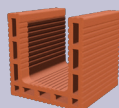

Profiblok vencovka 365 / <b>PB-V365</b>	365 mm	72	240 × 365 × 238	9,80	8,0	43,8	4,51	-	-	5,41	-	-
Profiblok vencovka 300 / <b>PB-V300</b>	300 mm	96	240 × 300 × 238	8,17	32,0	53,3	3,58	-	-	4,30	-	-
Profiblok vencovka 240 / <b>PB-V240</b>	240 mm	96	240 × 240 × 238	8,01	10,7	44,4	2,90	-	-	3,48	-	-
Profiblok vencovka 175 / <b>PB-V175</b>	175 mm	144	240 × 175 × 238	7,25	8,0	45,7	2,16	-	-	2,59	-	-

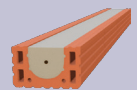
	Názov/ Katalógové označenie	Hrúbka steny	Hmot. kg/ks	Rozmer (mm) d x š x v	Bal. ks/pal	Maximálna svetlosť otvoru (mm)	Cena bez DPH/ks	Cena s DPH/ks
<b>Nosné preklady</b>  	Preklad1000 / <b>PB-70/238-1000</b>	<b>440 mm</b> <b>400 mm</b> <b>365 mm</b> <b>300 mm</b> <b>240 mm</b> <b>140 mm</b>	35,7	1000 × 70 × 238	20	750	<b>13,76</b>	<b>16,51</b>
	Preklad1250 / <b>PB-70/238-1250</b>		44,8	1250 × 70 × 238	20	1000	<b>18,26</b>	<b>21,91</b>
	Preklad1500 / <b>PB-70/238-1500</b>		54,0	1500 × 70 × 238	20	1250	<b>22,05</b>	<b>26,46</b>
	Preklad1750 / <b>PB-70/238-1750</b>		63,1	1750 × 70 × 238	20	1500	<b>28,83</b>	<b>34,60</b>
	Preklad2000 / <b>PB-70/238-2000</b>		72,3	2000 × 70 × 238	20	1600	<b>37,35</b>	<b>44,82</b>
	Preklad2250 / <b>PB-70/238-2250</b>		82,0	2250 × 70 × 238	20	1850	<b>43,09</b>	<b>51,71</b>
	Preklad2500 / <b>PB-70/238-2500</b>		91,1	2500 × 70 × 238	20	2000	<b>46,03</b>	<b>55,24</b>
	Preklad2750 / <b>PB-70/238-2750</b>		100,2	2750 × 70 × 238	20	2250	<b>49,25</b>	<b>59,10</b>
	Preklad3000 / <b>PB-70/238-3000</b>		109,4	3000 × 70 × 238	20	2500	<b>52,16</b>	<b>62,59</b>
	Preklad3250 / <b>PB-70/238-3250</b>		118,5	3250 × 70 × 238	20	2750	<b>56,18</b>	<b>67,42</b>
	Preklad3500 / <b>PB-70/238-3500</b>		127,6	3500 × 70 × 238	20	3000	<b>64,84</b>	<b>77,81</b>
<b>Nenosné preklady</b>  	Preklad1000 / <b>PB-175/71-1000</b>	<b>175 mm</b>	19,3	1000 × 175 × 71	30	750	<b>10,91</b>	<b>13,09</b>
	Preklad1250 / <b>PB-175/71-1250</b>		24,1	1250 × 175 × 71	30	1000	<b>13,76</b>	<b>16,51</b>
	Preklad1500 / <b>PB-175/71-1500</b>		29,2	1500 × 175 × 71	30	1250	<b>17,08</b>	<b>20,50</b>
	Preklad1750 / <b>PB-175/71-1750</b>		34,1	1750 × 175 × 71	30	1500	<b>20,40</b>	<b>24,48</b>
	Preklad2000 / <b>PB-175/71-2000</b>		39,5	2000 × 175 × 71	20	1750	<b>23,89</b>	<b>28,67</b>
	Preklad2250 / <b>PB-175/71-2250</b>		44,4	2250 × 175 × 71	20	2000	<b>26,56</b>	<b>31,87</b>
	Preklad2500 / <b>PB-175/71-2500</b>		49,3	2500 × 175 × 71	20	2250	<b>30,21</b>	<b>36,25</b>
	Preklad2750 / <b>PB-175/71-2750</b>		54,3	2750 × 175 × 71	20	2500	<b>33,53</b>	<b>40,24</b>
	Preklad3000 / <b>PB-175/71-3000</b>		60,1	3000 × 175 × 71	20	2750	<b>36,38</b>	<b>43,66</b>
	Preklad1000 / <b>PB-115/71-1000</b>	<b>115 mm</b>	16,0	1000 × 115 × 71	49	750	<b>8,33</b>	<b>10,00</b>
	Preklad1250 / <b>PB-115/71-1250</b>		20,0	1250 × 115 × 71	49	1000	<b>10,89</b>	<b>13,07</b>
	Preklad1500 / <b>PB-115/71-1500</b>		24,4	1500 × 115 × 71	49	1250	<b>12,94</b>	<b>15,53</b>
	Preklad1750 / <b>PB-115/71-1750</b>		28,4	1750 × 115 × 71	49	1500	<b>15,91</b>	<b>19,09</b>
	Preklad2000 / <b>PB-115/71-2000</b>		32,5	2000 × 115 × 71	35	1750	<b>18,26</b>	<b>21,91</b>
	Preklad2250 / <b>PB-115/71-2250</b>		37,2	2250 × 115 × 71	35	2000	<b>20,53</b>	<b>24,64</b>
	Preklad2500 / <b>PB-115/71-2500</b>		41,4	2500 × 115 × 71	35	2250	<b>23,40</b>	<b>28,08</b>
	Preklad2750 / <b>PB-115/71-2750</b>		45,5	2750 × 115 × 71	28	2500	<b>26,35</b>	<b>31,62</b>
	Preklad3000 / <b>PB-115/71-3000</b>		49,6	3000 × 115 × 71	28	2750	<b>28,31</b>	<b>33,97</b>
	<b>Palety a služby</b>	Názov/ Katalógové označenie	mj.					Cena bez DPH/mj.
Paleta KM BETA		1 ks					<b>16,00</b>	<b>19,20</b>
Nevratný drevený preklad		1 ks					<b>2,50</b>	<b>3,00</b>
	Vykládka hydraulickou rukou	1 ks					<b>6,00</b>	<b>7,20</b>

## Tip

### Chcete urýchliť svoju stavbu?

Klasická technológia murovania je pracná, trvá dlho a vyžaduje si presnosť.

Aby sme vám murovanie uľahčili, vyvinuli sme novú technológiu robotického prípravy tehlových stien vyrobených na mieru podľa vášho projektu.

Tým získate hneď niekoľko výhod:



rýchlu a presnú výstavbu



úsporu peňazí



uľahčenie práce remeselníkom



# Stropné systémy

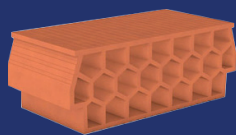

Miako

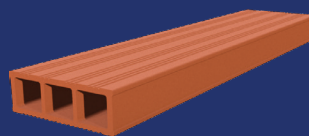

Hurdis

	Názov/ Katalógové označenie	Počet ks / pal	Hmot. kg/ks	Rozmer (mm) d x š x v	Cena bez DPH/ks	Cena s DPH/ks
Stropné vložky	Miako 15 / 62,5 / SM-150	80	14,3	250 × 525 × 150	<b>2,80</b>	<b>3,36</b>
	Miako 19 / 62,5 / SM-190	64	16,4	250 × 525 × 190	<b>3,40</b>	<b>4,08</b>

	Názov/ Katalógové označenie	Počet ks / pal	Hmot. kg/ks	Rozmer (mm) d x š x v	Cena bez DPH/ks	Cena s DPH/ks
Stropné vložky	Hurdis 1 rovné čelo / SH-RC	60	17,1	980 × 250 × 80	<b>8,29</b>	<b>9,95</b>
	Hurdis 2 šikmé čelo / SH-SC	60	16,8	1000 × 250 × 80	<b>8,29</b>	<b>9,95</b>

	Názov/ Katalógové označenie	Počet ks / pal	Hmot. kg/ks	Rozmer (mm) d x š x v	Cena bez DPH/ks	Cena s DPH/ks
Stropné nosníky	Stropný nosník MIAKO / SM-N-1750		38,9	1750 × 160 × 189	<b>20,00</b>	<b>24,00</b>
	Stropný nosník MIAKO / SM-N-2000		44,4	2000 × 160 × 189	<b>22,00</b>	<b>26,40</b>
	Stropný nosník MIAKO / SM-N-2250		50,0	2250 × 160 × 189	<b>25,00</b>	<b>30,00</b>
	Stropný nosník MIAKO / SM-N-2500		55,5	2500 × 160 × 189	<b>28,00</b>	<b>33,60</b>
	Stropný nosník MIAKO / SM-N-2750		61,1	2750 × 160 × 189	<b>30,00</b>	<b>36,00</b>
	Stropný nosník MIAKO / SM-N-3000		66,6	3000 × 160 × 189	<b>37,00</b>	<b>44,40</b>
	Stropný nosník MIAKO / SM-N-3250		72,2	3250 × 160 × 189	<b>40,00</b>	<b>48,00</b>
	Stropný nosník MIAKO / SM-N-3500		79,4	3500 × 160 × 189	<b>43,00</b>	<b>51,60</b>
	Stropný nosník MIAKO / SM-N-3750		85,1	3750 × 160 × 189	<b>46,00</b>	<b>55,20</b>
	Stropný nosník MIAKO / SM-N-4000		90,7	4000 × 160 × 189	<b>54,00</b>	<b>64,80</b>
	Stropný nosník MIAKO / SM-N-4250		98,8	4250 × 160 × 189	<b>58,00</b>	<b>69,60</b>
	Stropný nosník MIAKO / SM-N-4500		104,6	4500 × 160 × 189	<b>63,00</b>	<b>75,60</b>
	Stropný nosník MIAKO / SM-N-4750		110,5	4750 × 160 × 189	<b>67,00</b>	<b>80,40</b>
	Stropný nosník MIAKO / SM-N-5000		121,0	5000 × 160 × 189	<b>73,00</b>	<b>87,60</b>
	Stropný nosník MIAKO / SM-N-5250		127,0	5250 × 160 × 189	<b>79,00</b>	<b>94,80</b>
	Stropný nosník MIAKO / SM-N-5500		133,1	5500 × 160 × 189	<b>83,00</b>	<b>99,60</b>
	Stropný nosník MIAKO / SM-N-5750		141,5	5750 × 160 × 189	<b>87,00</b>	<b>104,40</b>
	Stropný nosník MIAKO / SM-N-6000		150,8	6000 × 160 × 189	<b>97,00</b>	<b>116,40</b>
	Stropný nosník MIAKO / SM-N-6250		161,6	6250 × 160 × 189	<b>101,00</b>	<b>121,20</b>
	Stropný nosník MIAKO / SM-N-6500		168,1	6500 × 160 × 189	<b>115,00</b>	<b>138,00</b>
	Stropný nosník MIAKO / SM-N-6750		174,5	6750 × 160 × 189	<b>123,00</b>	<b>147,60</b>
	Stropný nosník MIAKO / SM-N-7000		181,0	7000 × 160 × 189	<b>134,00</b>	<b>160,80</b>
	Stropný nosník MIAKO / SM-N-7250		187,5	7250 × 160 × 189	<b>137,00</b>	<b>164,40</b>
	Stropný nosník MIAKO / SM-N-7500		197,2	7500 × 160 × 189	<b>výroba na objednávku</b>	
	Stropný nosník MIAKO / SM-N-7750		203,8	7750 × 160 × 189	<b>výroba na objednávku</b>	
	Stropný nosník MIAKO / SM-N-8000		210,4	8000 × 160 × 189	<b>výroba na objednávku</b>	
	Stropný nosník MIAKO / SM-N-8250		217,0	8250 × 160 × 189	<b>výroba na objednávku</b>	

	Názov/ Katalógové označenie	Počet ks / pal	Hmot. kg/ks	Rozmer (mm) d x š x v	Cena bez DPH/ks	Cena s DPH/ks
Stropné nosníky	Stropný nosník HURDIS 2 na šikmé čelo / SH-N-1750		61,2	1750 × 255 × 237	<b>20,11</b>	<b>24,14</b>
	Stropný nosník HURDIS 2 na šikmé čelo / SH-N-2000		69,9	2000 × 255 × 237	<b>22,60</b>	<b>27,12</b>
	Stropný nosník HURDIS 2 na šikmé čelo / SH-N-2250		78,7	2250 × 255 × 237	<b>25,50</b>	<b>30,59</b>
	Stropný nosník HURDIS 2 na šikmé čelo / SH-N-2500		87,4	2500 × 255 × 237	<b>28,42</b>	<b>34,10</b>
	Stropný nosník HURDIS 2 na šikmé čelo / SH-N-2750		97,4	2750 × 255 × 237	<b>31,33</b>	<b>37,59</b>
	Stropný nosník HURDIS 2 na šikmé čelo / SH-N-3000		106,3	3000 × 255 × 237	<b>38,46</b>	<b>46,15</b>
	Stropný nosník HURDIS 2 na šikmé čelo / SH-N-3250		117,0	3250 × 255 × 237	<b>41,64</b>	<b>49,97</b>
	Stropný nosník HURDIS 2 na šikmé čelo / SH-N-3500		126,0	3500 × 255 × 237	<b>44,90</b>	<b>53,88</b>
	Stropný nosník HURDIS 2 na šikmé čelo / SH-N-3750		137,5	3750 × 255 × 237	<b>48,07</b>	<b>57,68</b>
	Stropný nosník HURDIS 2 na šikmé čelo / SH-N-4000		146,7	4000 × 255 × 237	<b>55,92</b>	<b>67,11</b>
	Stropný nosník HURDIS 2 na šikmé čelo / SH-N-4250		155,9	4250 × 255 × 237	<b>60,34</b>	<b>72,41</b>
	Stropný nosník HURDIS 2 na šikmé čelo / SH-N-4500		165,0	4500 × 255 × 237	<b>65,29</b>	<b>78,34</b>
	Stropný nosník HURDIS 2 na šikmé čelo / SH-N-4750		175,3	4750 × 255 × 237	<b>70,31</b>	<b>84,37</b>
	Stropný nosník HURDIS 2 na šikmé čelo / SH-N-5000		186,6	5000 × 255 × 237	<b>76,20</b>	<b>91,44</b>
	Stropný nosník HURDIS 2 na šikmé čelo / SH-N-5250		197,4	5250 × 255 × 237	<b>82,57</b>	<b>99,08</b>
	Stropný nosník HURDIS 2 na šikmé čelo / SH-N-5500		208,7	5500 × 255 × 237	<b>86,27</b>	<b>103,53</b>
	Stropný nosník HURDIS 2 na šikmé čelo / SH-N-5750		220,4	5750 × 255 × 237	<b>90,69</b>	<b>108,83</b>
	Stropný nosník HURDIS 2 na šikmé čelo / SH-N-6000		232,6	6000 × 255 × 237	<b>101,11</b>	<b>121,33</b>
	Stropný nosník HURDIS 2 na šikmé čelo / SH-N-6250		245,4	6250 × 255 × 237	<b>105,33</b>	<b>126,39</b>
	Stropný nosník HURDIS 2 na šikmé čelo / SH-N-6500		253,5	6500 × 255 × 287	<b>120,16</b>	<b>144,20</b>
	Stropný nosník HURDIS 2 na šikmé čelo / SH-N-6750		263,2	6750 × 255 × 287	<b>128,79</b>	<b>154,55</b>
	Stropný nosník HURDIS 2 na šikmé čelo / SH-N-7000		276,5	7000 × 255 × 287	<b>140,27</b>	<b>168,32</b>
	Stropný nosník HURDIS 2 na šikmé čelo / SH-N-7250		286,3	7250 × 255 × 287	<b>143,81</b>	<b>172,57</b>

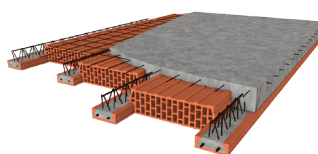

Stropný systém MIAKO

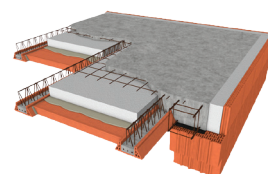

Stropný systém HURDIS

	Názov	Katalóg. označenie	Objem/ ml	Výdatnosť 1 dózy na tehlové murivo / m <sup>2</sup> (šírka muríva 175 -440 mm)	Výdatnosť 1 dózy na tehlové mur. / m <sup>2</sup> (šírka muríva 80 - 440 mm)	Cena bez DPH/ ks	Cena s DPH/ks			
<b>Pena</b>	Murovacíá Pena	<b>ZP</b>	750 ml	5,5	11	<b>13,41</b>	<b>16,09</b>			
	Názov	Katalóg. označenie	Zrinitosť	Dop. hrúbka vrstvy (mm)	Balenie vreće (kg)	Balenie pal / ks	Spotreba pri dop. hrúbke (kg/m <sup>2</sup> )	Cena bez DPH/t	Cena bez DPH/ bal	Cena s DPH/bal
<b>Murovacíe malty</b> (brúsené pálené murivo Profiblok)	Zakladacia malta pre pálené murivo a pórobeton (10 N/mm <sup>2</sup> )	<b>ZM-910</b>	4,0	10	25	48	18,0	<b>270</b>	<b>6,75</b>	<b>8,10</b>
	- so zimnou úpravou ❄️	<b>ZM-910-Z</b>	4,0	10	25	48	18,0	<b>294</b>	<b>7,35</b>	<b>8,82</b>
	Lepidlo celoplošné (10 N/mm <sup>2</sup> )	<b>ZM-911</b>	0,7	3	25	48	2,3	<b>603</b>	<b>15,08</b>	<b>18,09</b>
	- so zimnou úpravou ❄️	<b>ZM-911-Z</b>	0,7	3	25	48	2,3	<b>627</b>	<b>15,68</b>	<b>18,81</b>
	Lepidlo na rebrá (10 N/mm <sup>2</sup> )	<b>ZM-912</b>	0,7	1	25	48	1,4	<b>343</b>	<b>8,58</b>	<b>10,29</b>
	- so zimnou úpravou ❄️	<b>ZM-912-Z</b>	0,7	1	25	48	1,4	<b>367</b>	<b>9,18</b>	<b>11,01</b>
	Murovacíá malta ľahčená (5 N/mm <sup>2</sup> )	<b>ZM-905</b>	2,0	12	25	48	18,0	<b>260</b>	<b>6,50</b>	<b>7,80</b>
- so zimnou úpravou ❄️	<b>ZM-905-Z</b>	2,0	12	25	48	18,0	<b>284</b>	<b>7,10</b>	<b>8,52</b>	
<b>Murovacíe malty</b> (Profiblok na maltu a betónové tvárnice)	Murovacíá cementová malta (10 N/mm <sup>2</sup> )	<b>ZM-901</b>	4,0	12	25	48	22,5	<b>151</b>	<b>3,78</b>	<b>4,53</b>
	- so zimnou úpravou ❄️	<b>ZM-901-Z</b>	4,0	12	25	48	22,5	<b>175</b>	<b>4,38</b>	<b>5,25</b>
	- jemná	<b>ZM-901j</b>	2,0	12	25	48	22,5	<b>156</b>	<b>3,90</b>	<b>4,68</b>
	- jemná so zimnou úpravou ❄️	<b>ZM-901j-Z</b>	2,0	12	25	48	22,5	<b>180</b>	<b>4,50</b>	<b>5,40</b>
	Murovacíá cementová malta (15 N/mm <sup>2</sup> )	<b>ZM-902</b>	4,0	12	40	30	22,5	<b>203</b>	<b>8,12</b>	<b>9,74</b>
	- so zimnou úpravou ❄️	<b>ZM-902-Z</b>	4,0	12	40	30	22,5	<b>227</b>	<b>9,08</b>	<b>10,90</b>
	Murovacíá malta vápenocementová (5 N/mm <sup>2</sup> )	<b>ZM-903</b>	4,0	12	25	48	21,0	<b>140</b>	<b>3,50</b>	<b>4,20</b>
	- jemná	<b>ZM-903j</b>	2,0	12	25	48	22,0	<b>147</b>	<b>3,68</b>	<b>4,41</b>
	Tepelnoizolačná murovacíá malta λ = 0,21 W/(m.K)	<b>TM-501</b>	2,0	12	40 l	40	13,8 l/m <sup>2</sup>		<b>14,56</b>	<b>17,47</b>
- so zimnou úpravou ❄️	<b>TM-501-Z</b>	2,0	12	40 l	40	13,8 l/m <sup>2</sup>		<b>16,85</b>	<b>20,22</b>	
<b>Murovacíe malty</b> (Sendwix a betónové bloky)	Murovacíá malta na vápennopieskové a betónové bloky (20 N/mm <sup>2</sup> )	<b>ZM-920</b>	4,0	12	25	48	21,7	<b>333</b>	<b>8,33</b>	<b>9,99</b>
	- so zimnou úpravou ❄️	<b>ZM-920-Z</b>	4,0	12	25	48	21,7	<b>357</b>	<b>8,93</b>	<b>10,71</b>
	Lepidlo na Sendwix a betónové bloky (10 N/mm <sup>2</sup> )	<b>ZM-921</b>	1,2	2	25	48	2,5	<b>359</b>	<b>8,98</b>	<b>10,77</b>
	- so zimnou úpravou ❄️	<b>ZM-921-Z</b>	1,2	2	25	48	2,5	<b>383</b>	<b>9,58</b>	<b>11,49</b>
- biele *	<b>ZM-921-B</b>	1,2	2	25	48	2,5	<b>395</b>	<b>9,88</b>	<b>11,85</b>	
<b>Murovacíe malty</b> (Pohľadové murivo)	Murovacíá a škárovacia malta pre lícové murivo (10 N/mm <sup>2</sup> )	<b>ZM-907</b>	2,0	12	25	48	18,0	<b>281</b>	<b>7,03</b>	<b>8,43</b>
	Škárovacia malta pre lícové murivo (5 N/mm <sup>2</sup> )	<b>ZM-908</b>	0,7	10	25	48	15,0	<b>271</b>	<b>6,78</b>	<b>8,13</b>
<b>Murovacíe malty</b> (Pórobeton)	Zakladacia malta (10 N/mm <sup>2</sup> )	<b>ZM-910</b>	4,0	10	25	48	18,0	<b>271</b>	<b>6,78</b>	<b>8,13</b>
	- so zimnou úpravou ❄️	<b>ZM-910-Z</b>	4,0	10	25	48	18,0	<b>294</b>	<b>7,35</b>	<b>8,82</b>
	Murovacíá malta na pórobeton (5 N/mm <sup>2</sup> )	<b>ZM-906</b>	0,7	2	25	48	3,3	<b>281</b>	<b>7,03</b>	<b>8,43</b>
	- so zimnou úpravou ❄️	<b>ZM-906-Z</b>	0,7	2	25	48	3,3	<b>305</b>	<b>7,63</b>	<b>9,15</b>
<b>Murovacíe malty</b> (Univerzálne)	Univerzálna murovacíá a omietková malta (2,5 N/mm <sup>2</sup> )									
	- vreće 25 kg	<b>ZM-904</b>	2,0	12 murov. / 15 omiet.	25	48	18 murov. / 22,5 omietanie	<b>156</b>	<b>3,90</b>	<b>4,68</b>
	- vreće 40 kg	<b>ZM-904-40</b>	2,0	12 murov. / 15 omiet.	40	30	18 murov. / 22,5 omietanie	<b>251</b>	<b>10,04</b>	<b>12,05</b>
Vápenná murovacíá malta	<b>ZM-909</b>	1,2	10	25	48	17,6	<b>167</b>	<b>4,18</b>	<b>5,01</b>	
<b>Stierky a potery</b> (podlahy)	Cementový poter (20 N/mm <sup>2</sup> )									
	- vreće 25 kg	<b>CP-101</b>	4,0	10 - 50	25	48	18,5 - 92,5	<b>151</b>	<b>3,78</b>	<b>4,53</b>
	- so zimnou úpravou ❄️	<b>CP-101-Z</b>	4,0	10 - 50	25	48	18,5 - 92,5	<b>170</b>	<b>4,25</b>	<b>5,10</b>
	- jemný	<b>CP-101j</b>	1,2	5 - 15	25	48	8,5 - 25,5	<b>224</b>	<b>5,60</b>	<b>6,72</b>
	- jemný so zimnou úpravou ❄️	<b>CP-101j-Z</b>	1,2	5 - 15	25	48	8,5 - 25,5	<b>242</b>	<b>6,05</b>	<b>7,26</b>
	vreće 40 kg	<b>CP-101-40</b>	4,0	10 - 50	40	30	18,5 - 92,5	<b>146</b>	<b>5,84</b>	<b>7,01</b>
	- so zimnou úpravou ❄️	<b>CP-101-Z-40</b>	4,0	10 - 50	40	30	18,5 - 92,5	<b>164</b>	<b>6,56</b>	<b>7,87</b>
	- jemný	<b>CP-101j-40</b>	1,2	5 - 15	40	30	8,5 - 25,5	<b>218</b>	<b>8,72</b>	<b>10,46</b>
- jemný so zimnou úpravou ❄️	<b>CP-101j-Z-40</b>	1,2	5 - 15	40	30	8,5 - 25,5	<b>237</b>	<b>9,48</b>	<b>11,38</b>	

Je možné murovať aj v zimnom období? Stavebnú sezónu môžete predĺžiť aj o zimné mesiace vďaka našej malte so zimnou úpravou. Murovať môžete aj pri teplotách - 5 °C. A ako spoznáte maltu so zimnou úpravou? Veľmi ľahko, od ostatných sa odlišuje písmenom „Z“ uvedenom v katalógovom označení. V cenníku je označená symbolom ❄️

	Názov	Katalógové označenie	Zrinitosť	Dop. hrúbka vrstvy (mm)	Balenie vrece (kg)	Balenie pal / ks	Spotreba pri dop. hrúbke (kg/m <sup>2</sup> )	Cena bez DPH/t	Cena bez DPH/ bal	Cena s DPH/bal
Stierky a potery (podlahy)	Cementový poter (25 N/mm <sup>2</sup> )									
	- vrece 25 kg	<b>CP-102</b>	4,0	10 - 50	25	48	18,5 - 92,5	<b>156</b>	<b>3,90</b>	<b>4,68</b>
	- so zimnou úpravou ❄️	<b>CP-102-Z</b>	4,0	10 - 50	25	48	18,5 - 92,5	<b>175</b>	<b>4,38</b>	<b>5,25</b>
	- jemný	<b>CP-102j</b>	1,2	5 - 15	25	48	8,5 - 25,5	<b>257</b>	<b>6,43</b>	<b>7,71</b>
	- jemný so zimnou úpravou ❄️	<b>CP-102j-Z</b>	1,2	5 - 15	25	48	8,5 - 25,5	<b>276</b>	<b>6,90</b>	<b>8,28</b>
	- vrece 40 kg	<b>CP-102-40</b>	4,0	10 - 50	40	30	18,5 - 92,5	<b>151</b>	<b>6,04</b>	<b>7,25</b>
	- so zimnou úpravou ❄️	<b>CP-102-Z-40</b>	4,0	10 - 50	40	30	18,5 - 92,5	<b>170</b>	<b>6,80</b>	<b>8,16</b>
	- jemný	<b>CP-102j-40</b>	1,2	5 - 15	40	30	8,5 - 25,5	<b>252</b>	<b>10,08</b>	<b>12,10</b>
	- jemný so zimnou úpravou ❄️	<b>CP-102j-Z-40</b>	1,2	5 - 15	40	30	8,5 - 25,5	<b>270</b>	<b>10,82</b>	<b>12,98</b>
	Cementový poter (30 N/ mm <sup>2</sup> )									
	- vrece 25 kg	<b>CP-103</b>	4,0	10 - 50	25	48	18,5 - 92,5	<b>167</b>	<b>4,18</b>	<b>5,01</b>
	- so zimnou úpravou ❄️		4,0	10 - 50	25	48	18,5 - 92,5	<b>185</b>	<b>4,63</b>	<b>5,55</b>
	- vrece 40 kg	<b>CP-103-40</b>	4,0	10 - 50	40	30	18,5 - 92,5	<b>161</b>	<b>6,44</b>	<b>7,73</b>
	- so zimnou úpravou ❄️	<b>CP-103-Z</b>	4,0	10 - 50	40	30	18,5 - 92,5	<b>180</b>	<b>7,20</b>	<b>8,64</b>
Špeciálny poter pre spádové podlahové konštrukcie	<b>CP-107</b>	4,0	5 - 100	25	48	9,7 - 195,0	<b>302</b>	<b>7,55</b>	<b>9,06</b>	
Samonivelizačná polymércementová stierka (25 N/mm <sup>2</sup> )	<b>CP-111</b>	0,7	5	25	48	7,0	<b>897</b>	<b>22,43</b>	<b>26,91</b>	
Samonivelizačná sádrová stierka (25 N/mm <sup>2</sup> )	<b>SP-115</b>	0,7	5	25	48	7,5	<b>536</b>	<b>13,40</b>	<b>16,08</b>	
Samonivelizačný sádrový poter (20 N/mm <sup>2</sup> )	<b>SP-120</b>	2,0	25 - 40	25	48	42,5 - 68,0	<b>220</b>	<b>5,50</b>	<b>6,60</b>	
Betónové zmesi	Betón B 30 (30 N/mm <sup>2</sup> ) C25/30	<b>BS-130</b>	4,0	10 - 50	25	48	20,0 - 60,0	<b>175</b>	<b>4,38</b>	<b>5,25</b>
	Rýchlortvrdnúca suchá betónová zmes	<b>BS-131</b>	4,0	10	25	48	20,0	<b>224</b>	<b>5,60</b>	<b>6,72</b>
	Opravný betón (čiastočne samorzlivový)	<b>BS-132</b>	4,0	10 - 30	25	48	18,5 - 55,5	<b>369</b>	<b>9,23</b>	<b>11,07</b>
Piesok	Kremičitý piesok	<b>KP-401</b>	2,0	-	25	48	-	<b>213</b>	<b>5,33</b>	<b>6,39</b>
Omiety a fasády (príprava podkladu)	Cementový postrek	<b>OM-201</b>	4,0	max. 3	40	30	5,5	<b>215</b>	<b>8,60</b>	<b>10,32</b>
	Podkladový spojovací mostík	<b>OM-209</b>	0,4	0,5	25	48	1,0	<b>632</b>	<b>15,80</b>	<b>18,96</b>
	Penetrácia základná	<b>PZ</b>	-	-	5 l	-	0,1 - 0,2		<b>12,79</b>	<b>15,35</b>
Omiety a fasády (jadrové)	Jadrová omiетка vápenocementová strojová									
	- vrece 25 kg	<b>OM-202</b>	1,2	max. 15	25	48	11,6*	<b>177</b>	<b>4,43</b>	<b>5,31</b>
	- vrece 40 kg	<b>OM-202-40</b>	1,2	max. 15	40	30	11,6*	<b>172</b>	<b>6,88</b>	<b>8,26</b>
	Jadrová omiетка vápenocementová strojová jemná									
	- vrece 25 kg	<b>OM-202j</b>	0,7	max. 10	25	48	12,1*	<b>192</b>	<b>4,80</b>	<b>5,76</b>
	- vrece 40 kg	<b>OM-202j-40</b>	0,7	max. 10	40	30	12,1*	<b>187</b>	<b>7,48</b>	<b>8,98</b>
	Jadrová omiетка vápenocementová ručná									
	- vrece 25 kg	<b>OM-203</b>	2,0	max. 20	25	48	16,0*	<b>172</b>	<b>4,30</b>	<b>5,16</b>
	- vrece 40 kg	<b>OM-203-40</b>	2,0	max. 20	40	30	16,0*	<b>166</b>	<b>6,64</b>	<b>7,97</b>
	Jadrová omiетка vápenocementová ručná hrubá									
	- vrece 25 kg	<b>OM-203h</b>	4,0	max. 25	25	48	17,0*	<b>174</b>	<b>4,35</b>	<b>5,22</b>
	- vrece 40 kg	<b>OM-203h-40</b>	4,0	max. 25	40	30	17,0*	<b>169</b>	<b>6,76</b>	<b>8,11</b>
	Jadrová omiетка vápenocementová ručná jemná									
	- vrece 25 kg	<b>OM-203-j</b>	1,2	max. 15	25	48	15,0*	<b>208</b>	<b>5,20</b>	<b>6,24</b>
	- vrece 40 kg	<b>OM-203j-40</b>	1,2	max. 15	40	30	15,0*	<b>198</b>	<b>7,92</b>	<b>9,50</b>
	Jadrová omiетка vápenná	<b>OM-204</b>	2,0	max. 10	25	48	12,7*	<b>234</b>	<b>5,85</b>	<b>7,02</b>
	Tepelnoizolačná omiетка λ = 0,12 W/(m.K)	<b>TO-502</b>	2,0	30	19 l	42	26,0 l/m <sup>2</sup>		<b>16,85</b>	<b>20,22</b>
Omietková zmes na opravu trhlín	<b>OM-210</b>	1,2	3	25	48	3,8	<b>510</b>	<b>12,75</b>	<b>15,30</b>	
Opravná malta na omiety	<b>OM-211</b>	2,0	10	25	48	12,8	<b>437</b>	<b>10,93</b>	<b>13,11</b>	
Špeciálna cementová malta na opravy (reprofiláciu) betónu a betónových dielcov										
- hrubá	<b>OM-212</b>	2,0	3 - 35	25	48	6 - 70	<b>780</b>	<b>19,50</b>	<b>23,40</b>	
- jemná	<b>OM-212j</b>	1,2	3 - 35	25	48	6 - 70	<b>832</b>	<b>20,80</b>	<b>24,96</b>	

\* spotreba pri hrúbke vrstvy 10 mm ❄️ Zimná úprava

	Názov	Katalógové označenie	Zrinitosť	Doporučená hrúbka vrstvy (mm)	Balenie vrece (kg)	Balenie pal / ks	Spotreba pri doporučenej hrúbke (kg/m <sup>2</sup> )	Cena bez DPH/t	Cena bez DPH/ bal	Cena s DPH/bal
Omiety a fasády (štukové)	Vnútrotná štuková omiетка vápenná	<b>JM-301</b>	0,7	max. 3	30	40	3,5	<b>250</b>	<b>7,50</b>	<b>9,00</b>
	- jemná	<b>JM-301j</b>	0,4	max. 2	30	40	3,0	<b>255</b>	<b>7,65</b>	<b>9,18</b>
	Vonkajšia štuková omiетка vápenocementová	<b>JM-302</b>	0,7	max. 2	30	40	4,1	<b>265</b>	<b>7,95</b>	<b>9,54</b>
	- jemná	<b>JM-302j</b>	0,4	max. 3	30	40	2,6	<b>270</b>	<b>8,10</b>	<b>9,72</b>
	Jednvrstvá omiетка ručná a strojová vápenocementová	<b>JM-303</b>	0,7	10	25	48	13,0	<b>156</b>	<b>3,90</b>	<b>4,68</b>
	Jednvrstvosvá zatieraná omiетка	<b>JM-304</b>	0,7	max. 3	40	30	3,8	<b>359</b>	<b>14,36</b>	<b>17,23</b>
Omiety a fasády (odvlhčovacie)	Jadrová sanačná odvlhčovacia omiетка	<b>OS-401</b>	4,0	min. 25	30	42	30,0	<b>671</b>	<b>20,13</b>	<b>24,16</b>
	Jemná sanačná odvlhčovacia omiетка	<b>OS-402</b>	0,7	min. 2,5	30	42	3,0	<b>681</b>	<b>20,43</b>	<b>24,52</b>
Lepidlá	Lepidlo štandard - C1T	<b>LM-702</b>	0,7	3-4 / 6-8 / 8-12 *	25	48	1,5-2,0/3-4/4-6	<b>213</b>	<b>5,33</b>	<b>6,39</b>
	Lepidlo klasik - C1TE	<b>LM-703</b>	0,7	3-4 / 6-8 / 8-12 *	25	48	1,5-2,0/3-4/4-6	<b>317</b>	<b>7,93</b>	<b>9,51</b>
	Lepidlo - C2T	<b>LM-704</b>	0,7	3-4 / 6-8 / 8-12 *	25	48	1,5-2,0/3-4/4-6	<b>437</b>	<b>10,93</b>	<b>13,11</b>
	Lepidlo super - C2TE	<b>LM-705</b>	0,7	3-4 / 6-8 / 8-12 *	25	48	1,5-2,0/3-4/4-6	<b>452</b>	<b>11,30</b>	<b>13,56</b>
	Lepidlo extraflex - C2TES1	<b>LM-706</b>	0,7	3-4 / 6-8 / 8-12 *	25	48	1,5-2,0/3-4/4-6	<b>562</b>	<b>14,05</b>	<b>16,86</b>
	Lepidlo rýchlotuhnúce - C1FT	<b>LM-707</b>	0,7	3-4 / 6-8 / 8-12 *	25	48	1,5-2,0/3-4/4-6	<b>848</b>	<b>21,20</b>	<b>25,44</b>
	Lepidlo na mozaiku - C1T	<b>LM-708</b>	0,7	3-4 / 6-8 / 8-12 *	25	48	1,5-2,0/3-4/4-6	<b>437</b>	<b>10,93</b>	<b>13,11</b>
	Lepidlo na mozaiku biele ** - C1T	<b>LM-708-B</b>	0,7	3-4 / 6-8 / 8-12 *	25	48	1,5-2,0/3-4/4-6	<b>510</b>	<b>12,75</b>	<b>15,30</b>
	Lepidlo super flex s odolnosťou proti výkvetom - C2TES1	<b>LM-709</b>	0,7	3-4 / 6-8 / 8-12 *	25	48	1,5-2,0/3-4/4-6	<b>687</b>	<b>17,18</b>	<b>20,61</b>
Fasádne stierky	Lepiacia a stierkováca hmota ETAG 004	<b>LM-710</b>	0,7	3-6	25	48	3,0-6,0	<b>437</b>	<b>10,93</b>	<b>13,11</b>
	- jemná	<b>LM-710j</b>	0,4	3-6	25	48	3,0-6,0	<b>447</b>	<b>11,18</b>	<b>13,41</b>
	Lepidlo univerzál	<b>LM-711</b>	0,7	lepenie dlažby: 3-4 / 6-8 / 8-12 lepenie izolantu a stierkovanie: 3-6	25	48	lepenie dlažby: 1,5-2,0/3-4/4-6 lepenie izolantu a stierkovanie: 3-6	<b>328</b>	<b>8,20</b>	<b>9,84</b>
Palety a služby	Názov		mj.				Cena bez DPH/ mj.		Cena s DPH/ mj.	
	Paleta KM BETA		1 ks				<b>16,00</b>		<b>19,20</b>	
	Vykládka hydraulickou rukou		1 ks				<b>6,00</b>		<b>7,20</b>	

\* Odporúčaná hrúbka vrstvy predstavuje výšku zuba zubového hladidla. \*\* Dodacia lehota je 30 dní odo dňa potvrdenia objednávky, požadovaný minimálny odber bude upresnený na základe vzájomnej dohody.

## SP 120 - Samonivelizačný sádrový poter

Vhodný na podlahové vykurovanie

Pochôdzny už po 24 hod.

Po realizácii nie je sprašný

Ideálne rovný

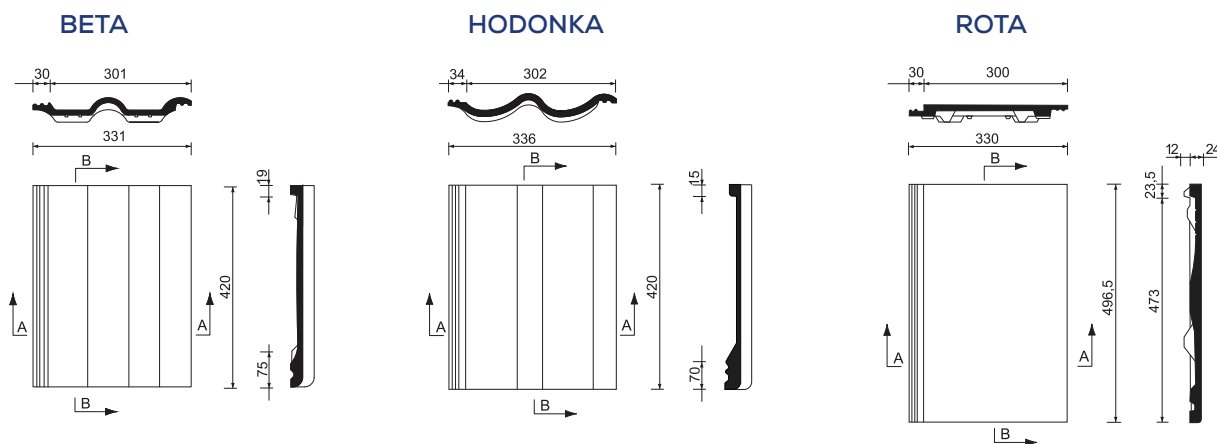

## VLASTNOSTI

	BETA	HODONKA	ROTA
Rozstup lát pri sklone strechy:	12-22° 320-325 mm 22-30° 320-330 mm > 30° 320-340 mm	12-22° 320-325 mm 22-30° 320-330 mm > 30° 320-340 mm	15-25° 396-402 mm 25-30° 396-406 mm > 30° 396-416 mm

VLASTNOSTI	BETA	HODONKA	ROTA	VLASTNOSTI	BETA	HODONKA	ROTA
Bezpečný sklon krytiny (°)	22	22	25	Dĺžka prvku (mm)	420	420	496,5
Rozmer lát (mm)	40/60 (dopor.)	40/60 (dopor.)	40/60	Šírka prvku (mm)	331	336	330
Plošná hmotnosť (kg/m <sup>2</sup> )	42,5	42,5	50,4	Hrúbka prvku (mm)	12	12	25
Hmotnosť (kg/ks)	4,25	4,25	6,3	Nasiakavosť (%)	max. 9	max. 9	max. 9
Objemová hmotnosť (kg/m <sup>3</sup> )	2250	2250	2250	Únosnosť (N)	2000	2000	1200
Spotreba (ks/m <sup>2</sup> )	10	10	8	Mrazuvzdornosť (cykly)	25	25	25
Trieda reakcie na oheň	A1 – nehorľavé	A1 – nehorľavé	A1 – nehorľavé	Krycia šírka (mm)	301	302	300
Výška vlny (mm)	26	33,5	-	Krycia dĺžka (mm)	320 – 340	320 – 340	396 - 416
Počet vln	2	2	-	Sklon strechy (°)	12–90	12–90	15-90
Norma	ČSN EN 490	ČSN EN 490	ČSN EN 490	Závesná dĺžka (mm)	401	405	473

## AKUSTIKA SENDWIX

Pri realizácii akustických deliacich stien sú vhodné murovacie prvky SENDWIX 16DF-LP, 8DF-LP AKU, 14DF-LP, 7DF-LP, 5DF-LP

Výrobok	Hrúbka steny (mm)	Stena s ometkou vážená laboratórna nepriezvučnosť Rw (dB)
8DF-LP AKU	240	57
7DF-LP	200	54
5DF-LP	240	55
5DF-LP	290	56

Výpočet potreby 1 vreca lepidla ZM 921 – Lepidlo na Sendwix a betónové bloky (25 kg), na počet kusov výrobkov SENDWIX:

SENDWIX 16DF-LDE	50 ks	SENDWIX 6DF-LDE	131 ks	SENDWIX 14DF-LP	57 ks
SENDWIX 12DF-LDE	65 ks	SENDWIX 5DF-LP	67 ks	SENDWIX 14DF-LDE	57 ks
SENDWIX 8DF-LDE	100 ks	SENDWIX 4DF-LDE	208 ks	SENDWIX 7DF-LP	114 ks
SENDWIX 8DF-LP AKU	100 ks	SENDWIX 2DF-LD	103 ks	SENDWIX 7DF-LDE	114 ks

# Chcete sa o našich materiáloch a ich použití dozvedieť viac?



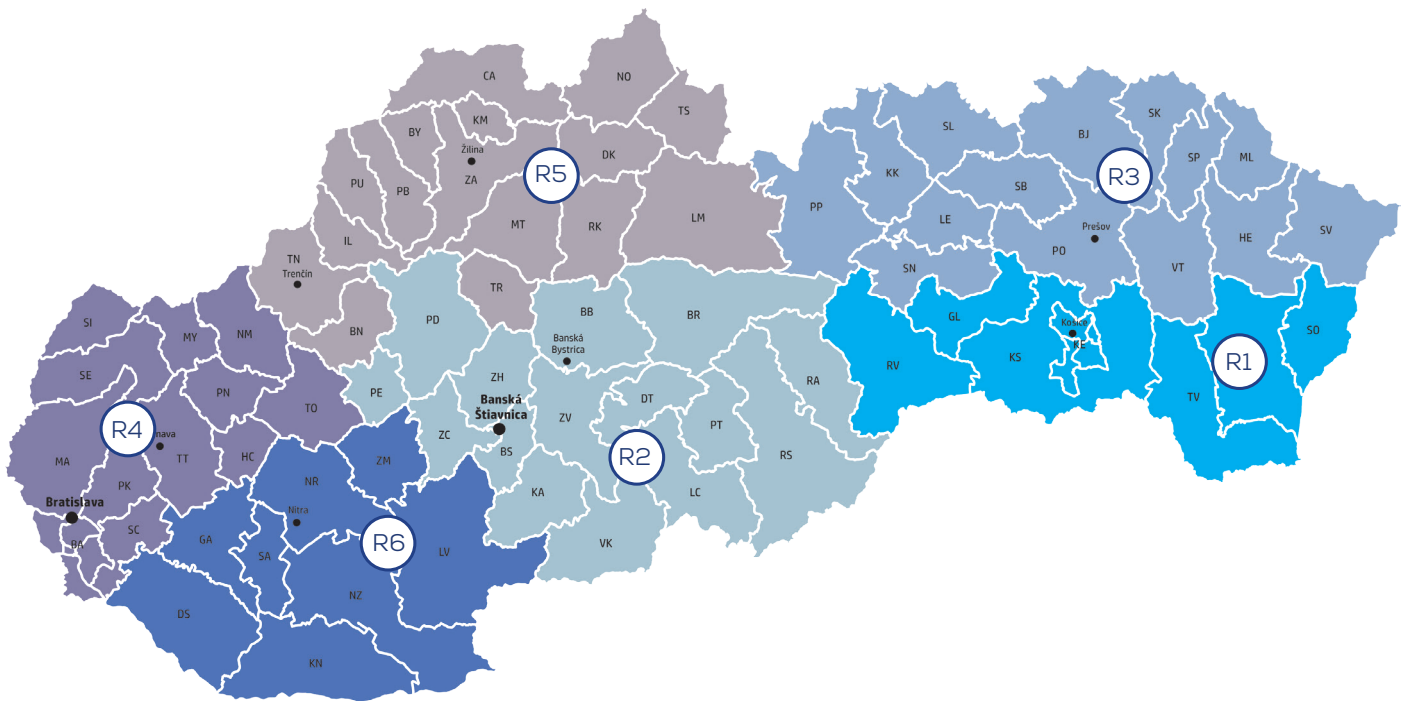

R1	r1@kmbeta.sk	+421 903 726 606 RV, GL, KS, KE, TV, MI, SO
R2	r2@kmbeta.sk	+421 903 726 606 BS, KA, VK, LC, DT, RS, RA, PT, BR, BB, ZV, PD, ZH, ZC, PE
R3	r3@kmbeta.sk	+421 911 950 405 PP, KK, SL, LE, SB, BJ, PO, SK, SP, VT, ML, HE, SV, SN
R4	r4@kmbeta.sk	+421 903 726 605 BA, SC, PK, MA, TT, SE, SI, MY, PN, HC, NM, TO
R5	r5@kmbeta.sk	+421 911 950 405 ZA, TR, MT, RK, LM, TS, DK, NO, CA, KM, BY, PB, PU, TN, IL, BN
R6	r6@kmbeta.sk	+421 911 726 605 NR, ZM, LV, NZ, SA, GA, KN, DS

## KM BETA, spol. s r. o.

Križovatka 25/921, 969 01 Banská Štiavnica

Tel.: +421 911 950 105

e-mail: kmbeta@kmbeta.sk, info@kmbeta.sk

e-mail objednávky: objednavky@kmbeta.sk

e-mail výpočty: vypocety@kmbeta.sk

Ceny sú uvedené s 20% DPH.

Zmeny technických údajov sú vyhradené. Vyobrazenia výrobkov sú ilustračné. Tento cenník platí od 1. 9. 2024 do vydania nového. Toto vydanie ruší platnosť všetkých predchádzajúcich vydání. Tlačové chyby sú vyhradené. Všetky obchodné vzťahy sa riadia platnými Všeobecnými obchodnými a dodacími podmienkami spoločnosti KM BETA, spol. s r.o..

Aktuálnu verziu cenníka a obchodných podmienok vždy nájdete na [www.kmbeta.sk](http://www.kmbeta.sk)

1. vydanie