

Cenník 2023

Platnosť od 24.7.2023



KM BETA



KM Beta Slovensko



@kmbeta_cz



KM BETA



kmbeta.sk

O spoločnosti KM Beta

Vyrábame pre vás strešnú krytinu, murovacie bloky, stropné systémy a suché maltové zmesi - jednoducho materiál pre celú hrubú stavbu.

Naše výrobky nájdete na mnohých predajných miestach. Najbližšiu predajňu, v ktorej si tovar môžete zakúpiť, vám odporučí náš regionálny manažér.

Poskytujeme:

- ✓ Nezáväznú kalkuláciu materiálu
- ✓ Poradenstvo
- ✓ Dopravu zadarmo po celej SR
- ✓ Dopravu tovaru vlastným vozidlom s hydraulickou rukou a jeho zloženie priamo na stavbe

Strešná krytina

Našu strešnú krytinu vyrábame v povrchových úpravách Prima, Samet, Briliant, Elegant a vo farbách tehlová (CI), hnedá (HN), višňová (VI), čierna (CE), šedá (SE), modrá (MO) a zelená (ZE).

Môžete si tak vybrať podľa svojho vkusu a charakteru vašej stavby.

**50 rokov
záruka**

na betónovú
strešnú krytinu

**15 rokov
záruka**
na strešný
systém

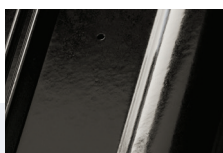

Prima (P) extra lesklá

Vytvára vysokohladký a lesklý povrch s efektom glazúry, dodáva väčšiu odolnosť a dlhú životnosť.



Samet (S) hladká a matná

Vytvára hladký povrch, dodáva krytine väčšiu odolnosť.



Briliant (B) lesklá

Dodáva strešnej krytine trblietanie vďaka aplikácii špeciálneho lesklého nástreku.

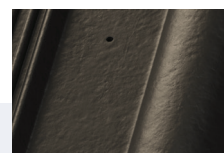

Elegant (E) matná

Dobre zapadne do tradičnej zástavy.



Beta



Hodonka

Prima	CI	HN	VI	CE			
Samet	CI	HN	VI	CE			
Briliant	CI	HN	VI	CE	SE		
Elegant	CI	HN	VI	CE	SE	MO*	ZE*

Briliant CI HN VI CE

Elegant CI HN VI CE



Rota

Prima CE

Briliant CE



Pre uplatnenie záruky 50 rokov zašlite do 3 mesiacov od polozenia krytiny vyplnený registračný formulár. Najneskôr však 12 mesiacov od termínu dodania krytiny.

Formulár nájdete na webovej stránke www.kmbeta.sk.

Pre ľahšie vyhľadanie môžete naskenovať QR kód.

* Modré a zelené škridly (Beta Elegant) sú iba na objednávku – cena je na vyžiadanie. Vopred sa platí záloha 50%. Plastové doplnkové škridly nie sú k dispozícii.

Strešná krytina



Beta



Rota



Hodonka



	Názov/ Kód výrobku	bal ks/ pal	Beta				Rota				Hodonka							
			Prima/Samet		Briliant		Elegant		Prima		Briliant		Briliant		Elegant			
			bez DPH/ ks	s DPH/ ks	bez DPH/ ks	s DPH/ ks	bez DPH/ ks	s DPH/ ks	ks/ pal	bez DPH/ ks	s DPH/ ks	bez DPH/ ks	s DPH/ ks	ks/ pal	bez DPH/ ks	s DPH/ ks	bez DPH/ ks	s DPH/ ks
Základné strešné škridle	Škridla základná / TZ	252	1,55	1,86	1,30	1,56	1,20	1,44	180	2,40	2,88	2,05	2,46	240	1,30	1,56	1,20	1,44
	Škridla polovičná / TP	160	1,80	2,16	1,55	1,86	1,40	1,68	120	2,60	3,12	2,30	2,76	160	1,55	1,86	1,40	1,68
Štítová hrana	Škridla okrajová																	
	- ľavá / TOL	32	5,05	6,06	4,70	5,64	4,50	5,40	32	8,27	9,92	8,05	9,66	32	4,70	5,64	4,50	5,40
	- pravá / TOP	32	5,05	6,06	4,70	5,64	4,50	5,40	32	8,27	9,92	8,05	9,66	32	4,70	5,64	4,50	5,40
	- ľavá polovičná / TOLP	-	-	-	-	-	-	-	48	8,48	10,17	8,27	9,93	-	-	-	-	-
	- pravá polovičná / TOPP	-	-	-	-	-	-	-	48	8,48	10,17	8,27	9,93	-	-	-	-	-
Vetranie	Škridla vetracia / TV	36	8,27	9,93	7,92	9,51	7,68	9,22	32	12,54	15,05	12,08	14,49	36	7,92	9,51	7,68	9,22
Zábrany proti snehu	Škridla protisnehová / TS	54	2,97	3,56	2,85	3,42	2,73	3,27	90	3,96	4,75	3,92	4,71	54	2,85	3,42	2,73	3,27
	Škridla sneholamu kovová / TSK	-	43,95	52,74	43,95	52,74	43,95	52,74	-	-	-	-	-	-	43,95	52,74	43,95	52,74
Nášlapy	Škridla nášlapná / TN	16	9,30	11,16	8,81	10,58	8,33	10,00	18	14,40	17,28	13,28	15,94	16	8,81	10,58	8,33	10,00
Strešné prestupy	Škridla prestupová / TPR	16	7,37	8,84	7,00	8,40	6,64	7,97	-	-	-	-	-	30	7,00	8,40	6,64	7,97
	Škr. betónová anténa / TBA	-	36,64	43,97	34,90	41,88	33,33	39,99	-	46,43	55,72	44,50	53,40	-	34,90	41,88	33,33	39,99
	Škr. oddymenia turbokotla / TOT	-	44,25	53,10	42,14	50,57	40,21	48,25	-	54,43	65,32	52,16	62,60	-	42,14	50,57	40,21	48,25
	Škr. beton. odvetrávacia komplet																	
	- Ø 110 mm / TBO110	-	63,70	76,43	60,68	72,81	57,78	69,33	-	83,09	99,71	79,63	95,56	-	60,68	72,81	57,78	69,33
	- Ø 150 mm / TBO150	-	140,84	169,00	132,87	159,45	125,35	150,42	-	-	-	-	-	-	-	-	-	-
	Škridla odvodňovacia / TO	-	9,78	11,74	9,29	11,15	8,81	10,58	-	-	-	-	-	-	-	-	-	-
	Škr. káblových prestupov / TKP	-	31,63	37,96	30,13	36,15	23,91	28,69	-	-	-	-	-	-	-	-	-	-
	Škridla hadicových prestupov / THP	-	32,96	39,56	31,40	37,67	24,51	29,41	-	-	-	-	-	-	-	-	-	
Hromozvod a kolektor	Škridla hromozvodová / THS	18	11,77	14,13	11,17	13,40	10,69	12,82	18	14,36	17,24	13,77	16,52	18	11,17	13,40	10,69	12,82
	Škridla kolektorová / TK	42	8,57	10,29	8,15	9,78	7,18	8,62	-	-	-	-	-	42	8,15	9,78	7,18	8,62
Pultová hrana	Škridla pultová																	
	- základná / TPZ	16	11,23	13,48	10,44	12,53	9,90	11,88	16	16,38	19,66	15,70	18,84	16	10,44	12,53	9,90	11,88
	- polovičná / TPP	24	11,59	13,91	10,81	12,97	10,26	12,32	16	16,63	19,96	15,94	19,13	24	10,81	12,97	10,26	12,32
	- okrajová ľavá / TLOL	-	13,16	15,79	12,56	15,07	11,95	14,35	16	27,36	32,83	26,21	31,45	-	12,56	15,07	11,95	14,35
	- okrajová pravá / TLOP	-	13,16	15,79	12,56	15,07	11,95	14,35	16	27,36	32,83	26,21	31,45	-	12,56	15,07	11,95	14,35
	- okrajová ľavá polovičná / TPOLP	-	-	-	-	-	-	-	48	30,84	37,01	28,62	34,34	-	-	-	-	-
	- okrajová pravá polovičná / TPOPP	-	-	-	-	-	-	-	48	30,84	37,01	28,62	34,34	-	-	-	-	-
	Hrebeňový tesniaci prvok / HTP	-	1,51	1,81	1,44	1,73	1,33	1,59	-	-	-	-	-	-	1,44	1,73	1,33	1,59
Manzardová a úžľabná hrana**	Škridla lomená																	
	- základná / TLZ	-	9,36	11,23	8,88	10,65	8,45	10,14	-	-	-	-	-	-	8,88	10,65	8,45	10,14
	- polovičná / TLP	-	9,60	11,52	9,12	10,94	8,69	10,43	-	-	-	-	-	-	9,12	10,94	8,69	10,43
	- okrajová ľavá / TLOL	-	18,54	22,24	17,63	21,16	16,78	20,14	-	-	-	-	-	-	17,63	21,16	16,78	20,14
	- okrajová pravá / TLOP	-	18,54	22,24	17,63	21,16	16,78	20,14	-	-	-	-	-	-	17,63	21,16	16,78	20,14
	Škridla úžľabná																	
	- základná / TUZ	-	9,36	11,23	8,88	10,65	8,45	10,14	-	-	-	-	-	-	8,88	10,65	8,45	10,14
	- polovičná / TUP	-	9,60	11,52	9,12	10,94	8,69	10,43	-	-	-	-	-	-	9,12	10,94	8,69	10,43
	- okrajová ľavá / TUOL	-	18,54	22,24	17,63	21,16	16,78	20,14	-	-	-	-	-	-	17,63	21,16	16,78	20,14
	- okrajová pravá / TUOP	-	18,54	22,24	17,63	21,16	16,78	20,14	-	-	-	-	-	-	17,63	21,16	16,78	20,14
Plastové strešné škridle	Škridla plastová																	
	- anténa / TPA	-	80,00	96,00	80,00	96,00	80,00	96,00	-	-	-	-	-	-	80,00	96,00	80,00	96,00
	- odvetrávacia Ø 110 mm / TPO110	-	-	-	-	-	-	-	-	-	-	-	-	-	130,0	156,0	130,0	156,0
	- odvetrávacia Ø 125 mm / TPO125	-	130,0	156,0	130,0	156,0	130,0	156,0	-	-	-	-	-	-	-	-	-	-
	- odvetrávacia Ø 160 mm / TPO160	-	140,0	168,0	140,0	168,0	140,0	168,0	-	-	-	-	-	-	-	-	-	-
	- presvetlovacia / TPLP	-	16,91	20,29	16,91	20,29	16,91	20,29	-	-	-	-	-	-	16,91	20,29	16,91	20,29

	Názov/ Kód výrobku	bal ks/ pal	Prima/Samet		Briliant		Elegant		Názov/ Kód výrobku	Balenie	MJ	bez DPH/ MJ	s DPH/ MJ	
			bez DPH/ks	s DPH/ ks	bez DPH/ks	s DPH/ ks	bez DPH/ks	s DPH/ ks						
Hrebeň	Hrebenáč / H	114	3,10	3,72	2,85	3,42	2,60	3,12	Násilapy	Nášlapný rošt vrátane držiakov				
	Hrebenáč krížový							- 600 mm / NRM		-	1 ks	65,02	78,02	
	- X / HKX		15,52	18,62	14,79	17,75	13,52	16,23		- 800 mm / NRV	-	1 ks	82,27	98,72
	- Y / HKY		15,52	18,62	14,79	17,75	13,52	16,23		Nášlap škridle vrátane držiaku / NT	-	1 ks	28,26	33,91
	- T / HKT		15,52	18,62	14,79	17,75	13,52	16,23		Vzpera plošiny univerzálna / VPU	-	1 ks	19,08	22,89
	- XB / HKXB		15,52	18,62	14,79	17,75	13,52	16,23		Zábrany proti snehu	Protisnehová zábrana / PZ	-	1 ks	1,80
	Hreb. hromozvodový / HH	48	8,69	10,43	8,27	9,93	7,91	9,49	Mreža sneholamu zosilnená s nitovaním 1800 x 200 mm / MS		-	1 ks	45,89	55,06
	Hrebenáč koncový								Vzpera mreže sneholamu / VMS		-	1 ks	12,56	15,07
	- hladký / HK	80	9,55	11,46	8,94	10,72	8,45	10,14	Hák na drevenú guľatinu / HDK		-	1 ks	24,15	28,98
	- lev / HLK		22,58	27,10	21,49	25,79	20,47	24,56	Strešné okná		Strešné okno výstupné			
	- vietor / HKV		22,58	27,10	21,49	25,79	20,47	24,56			- Beta 450 x 730 mm / SOVBV	-	1 ks	260,00
	Hrebeňová upchávka									- Beta 460 x 510 mm * / SOVBM	-	1 ks	180,00	216,00
	- slnečnica / HUS		8,88	10,65	8,45	10,14	8,09	9,71		Strešné okno kovové				
	- holubica / HUHO		8,88	10,65	8,45	10,14	8,09	9,71		- Beta 500 x 600 mm / SOVBK	-	1 ks	185,00	222,00
	- hladká / HUH		8,51	10,22	8,09	9,71	7,79	9,34		- Hodonka 500 x 600 mm / SOVHK	-	1 ks	185,00	222,00
	- slnko / HUSL		8,88	10,65	8,45	10,14	8,09	9,71	- Rota 600 x 600 mm / SOVRK	-	1 ks	180,00	216,00	
	- hrozno / HUHR		8,88	10,65	8,45	10,14	8,09	9,71	Strešné prestupy	Plastové viečko / PLV	-	1 ks	1,33	1,59
	- plastová / HU		1,63	1,96	1,63	1,96	1,63	1,96		Hydroizolačný prestupový krúžok				
	Hrebeňový okrasný prvok									- Ø 110 mm / HPK	-	1 ks	3,80	4,56
	- vežička / HOPV		65,93	79,12	62,79	75,35	57,84	69,41		- Ø 150 mm / HPK150	-	1 ks	4,00	4,80
- hrdličky / HOPH		65,93	79,12	62,79	75,35	57,84	69,41	Fólie a pásy	Hydroizolačné fólie					
- kohút / HOPK		65,93	79,12	62,79	75,35	57,84	69,41		- KM BETA 150 s aplikačnou páskou / HF150TT	50 bm / 75 m ² rolka	1m ²	2,13	2,55	
									- JUTADACH - 135 2AP s aplikačnou páskou / HF1352AP	50 bm / 75 m ² rolka	1m ²	3,22	3,86	
									- JUTADACH - 150 2AP s aplikačnou páskou / HF1502AP	50 bm / 75 m ² rolka	1m ²	3,50	4,20	
									- DELTA - MAXX PLUS / HFDMP	50 bm / 75 m ² rolka	1m ²	4,71	5,65	
									- DELTA FOXX - PLUS / HFDFP	50 bm / 75 m ² rolka	1m ²	5,74	6,88	
									DELTA - HF PRIMER / DHP	1 l / fľaša	1 ks	29,00	34,80	
									Lepidlo DELTA THAN / LDT	310 ml / kartuša	1 ks	16,54	19,85	
									Lepiaci páska DELTA - MULTI - BAND	25 bm/rolka	1rol	23,55	28,26	
									Tesniaca páska					
									- DELTA FLEXX - BAND / TPDFB	10 bm / rolka	1rol	43,95	52,74	
									- DELTA SB 60 / TPNDB	30 bm / rolka	1bm	1,03	1,23	
									Samolepiaci pás na fólie / SPF	25 bm / rolka	1bm	1,27	1,52	
									Butylkaučuková lepiaca páska / BLP	rolka	1bm	0,91	1,09	
Úžľabie	Pás úžľabia so stredovou drážkou							Odkvapový plech						
	- medený / MPU	2 bm v balení	1 ks	155,25	186,30			- hliníkový / HOP	2 bm	1ks	18,40	22,08		
	- hliníkový / HPU	2 bm v balení	1 ks	30,13	36,16			- medený / MOP	2 bm	1 ks	62,10	74,52		
	Tesniaca lišta úžľabia / TLU	300ks/krabica	1 ks	1,85	2,22			Lemovací pás / LP	5 bm / rolka	1 bm	22,20	26,63		
Vetracie	Tesniaci pás úžľabia TPU		1 ks	10,75	12,90			Krycia lišta lemovacího pásu / KLLP	-	1 ks	11,96	14,35		
	Ochranná vetracia mriežka							Spojovací materiál a palety	Adaptér pre vodorovné vedenie bleskozvodu / AVVH	-	1 ks	3,01	3,62	
	- jednoduchá / OVMJ	300 ks/krabica	1 ks	1,27	1,52				Prichytka škridle / PT	-	1 ks	0,30	0,36	
	- univerzálna / OVMU	50 ks v krabici	1 ks	3,02	3,63				Paleta 120x80	-	1 ks	16,00	19,20	
	Ochranný pás proti vtákom								Paleta 100x120	-	1 ks	16,00	19,20	
	- šírka 50 mm * / OP50	5 bm rolka	1 bm	1,15	1,38				Vykládka hydraulickou rukou	-	1 ks	5,00	6,00	
- šírka 80 mm / OP80	5 bm rolka	1 bm	1,27	1,52										
- šírka 100 mm / OP100	5 bm rolka	1 bm	1,33	1,59										

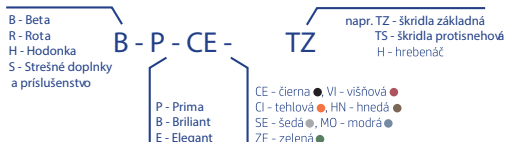
Katalógové označenie:

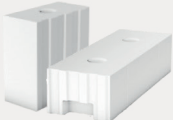

Prehľad prvkov Sendwix

Kategórie	290 mm	240 mm	200 mm	175 mm	150 mm	115 mm
Murovacie bloky - modulová dĺžka 500 mm 	-	SND-16DF-LDE SND-16DF-LPE	SND-14DF-LDE SND-14DF-LP	SND-12DF-LDE SND-12DF-LDZE SND-12DF-LDZHE	SND-10DF-LPE	-
- modulová dĺžka 250 mm 	-	SND-8DF-LDE SND-8DF-LP AKU	SND-7DF-LDE SND-7DF-LP	SND-6DF-LDE SND-6DF-LDZE SND-6DF-LDZHE	-	SND-4DF-LDE
Doplnkové bloky 	SND-5DF-LP	SND-5DF-LP SND-2DF-LD SND-1/2 8DF-LPE	SND-1/2 14DF-LDE	SND-1/2 12DF-LDE	SND-1/2 10DF-LPE	SND-2DF-LD
Tepelnoizolačné bloky (Therm) 	SND-4DF-D THERM + SND-12DF-D THERM	SND-16DF-D THERM	SND-14DF-D THERM	SND-12DF-D THERM	SND-10DF-D THERM	SND-4DF-D THERM
Vencovky 	-	SND-8DF-U	SND-7DF-U	SND-6DF-U	SND-5DF-U	SND-2DF-U
Preklady 	SND-2DF + SND-6DF	SND-8DF (nebo 2 × SND-2DF)	SND-7DF	SND-6DF	SND-5DF	SND-2DF
Spotreba lepidla - pre modulovú výšku 250 mm (kg/m ² muriva) - pre modulovú výšku 125 mm (kg/m ² muriva) *	12,3 *	4,0	3,5	3,0	2,5	2,0

Katalógové označenie:

SND - obchodný názov vápennopieskových kvádrov

SND - 8DF - LDE (P, U, Z, H)

8DF - označenie formátu

E - elektrokanáliky







D - dierovaný formát

P - plný formát
 U - U profil
 Z - zkosená pohľadová hrana
 H - hladká styčná plocha

L - výrobok pre tenkovrstvové murovanie na lepidlo

Murovacie bloky



Názov/ Katalógové označenie	Hrúbka steny	Balenie ks/pal	Rozmer (mm) d x š x v	Hmotnosť kg/ks	Spotreba ks/m ²	Spotreba ks/m ³	Cena bez DPH/ks	Cena bez DPH/m ²	Cena s DPH/ks	Cena s DPH/m ²
Sendwix 5DF-LP / SND-5DF-LP 	290 / 240	72	290 × 240 × 123	15,7	33 / 27	110 / 112	1,50	40,50	1,80	48,60
Sendwix 2DF-LD / SND-2DF-LD	240 / 115	196	240 × 115 × 123	6,2	65 / 33	283 / 271	0,75	24,75	0,90	29,70
Sendwix 16DF-LDE / SND-16DF-LDE	240 mm	24	498 × 240 × 248	37,2	8,0	33,5	5,20	41,60	6,24	49,92
Sendwix 16DF-LDE / SND-16DF-LPE 		24	498 × 240 × 248	57,5	8,0	33,5	5,72	45,76	6,86	54,91
Sendwix 8DF-LDE / SND-8DF-LDE 		48	248 × 240 × 248	19,8	16,0	67,0	2,60	41,60	3,12	49,92
Sendwix 8DF-LP AKU / SND-8DF-LP-AKU 		48	248 × 240 × 248	27,0	16,0	67,0	2,80	44,80	3,36	53,76
Sendwix 1/2 8DF-LPE / SND-1/2-8DF-LPE		64	123 × 240 × 248	14,2	32,0	134,0	2,90	92,80	3,48	111,36
Sendwix 14DF-LDE / SND-14DF-LDE 		200 mm	32	498 × 200 × 248	31,8	8,0	40,0	4,40	35,20	5,28
Sendwix 14DF-LP / SND-14DF-LP	24		498 × 200 × 248	48,0	8,0	40,0	4,90	39,16	5,87	46,99
Sendwix 1/2 14DF-LDE / SND-1/2-14DF-LDE	64		498 × 200 × 123	17,2	16,0	80,0	4,50	72,00	5,40	86,40
Sendwix 7DF-LDE / SND-7DF-LDE 	64		248 × 200 × 248	16,9	16,0	80,0	2,30	36,80	2,76	44,16
Sendwix 7DF-LP / SND-7DF-LP	48		248 × 200 × 248	22,4	16,0	80,0	2,50	40,00	3,00	48,00
Sendwix 12DF-LDE / SND-12DF-LDE	175 mm		32	498 × 175 × 248	28,1	8,0	45,7	3,90	31,20	4,68
Sendwix 12DF-LDZE / SND-12DF-LDZE		32	498 × 175 × 248	27,6	8,0	45,7	4,30	34,40	5,16	41,28
Sendwix 12DF-LDZHE / SND-12DF-LDZHE		32	498 × 175 × 248	28,3	8,0	45,7	4,30	34,40	5,16	41,28
Sendwix 1/2 12DF-LDE / SND-1/2-12DF-LDE		64	498 × 175 × 123	15,2	16,0	91,4	3,85	61,60	4,62	73,92
Sendwix 6DF-LDE / SND-6DF-LDE		64	248 × 175 × 248	16,2	16,0	91,4	2,05	32,80	2,46	39,36
Sendwix 6DF-LDZE / SND-6DF-LDZE		64	248 × 175 × 248	12,4	16,0	91,4	2,20	35,20	2,64	42,24
Sendwix 6DF-LDZHE / SND-6DF-LDZHE		64	248 × 175 × 248	16,4	16,0	91,4	2,20	35,20	2,64	42,24
Sendwix 10DF-LPE / SND-10DF-LPE 		150 mm	36	498 × 150 × 248	38,0	8,0	53,3	4,80	38,40	5,76
Sendwix 1/2 10DF-LPE / SND-1/2-10DF-LPE	72		498 × 150 × 123	18,5	16,0	106,7	4,80	76,80	5,76	92,16
Sendwix 4DF-LDE / SND-4DF-LDE	115 mm	84	248 × 115 × 248	11,1	16,0	139,0	1,30	20,80	1,56	24,96
Sendwix P7 / SND-P7	70 mm	84	498 × 70 × 240	16,5	8,0	114,3	4,73	37,84	5,68	45,41

Thermy



Sendwix 16DF-D THERM / SND-16DF-D THERM	240 mm	48	498 × 240 × 113	18,2	-	-	17,53	-	21,03	-
Sendwix 14DF-D THERM / SND-14DF-D THERM	200 mm	60	498 × 200 × 113	15,0	-	-	16,26	-	19,51	-
Sendwix 12DF-D THERM / SND-12DF-D THERM	175 mm	60	498 × 175 × 113	13,0	-	-	15,00	-	18,00	-
Sendwix 10DF-D THERM / SND-10DF-D THERM	150 mm	72	498 × 150 × 113	11,5	-	-	13,79	-	16,55	-
Sendwix 4DF-D THERM / SND-4DF-D THERM	115 mm	96	498 × 115 × 113	8,3	-	-	12,47	-	14,96	-

Vencovky



Sendwix 8DF-U / SND-8DF-U	240 mm	48	250 × 240 × 240	15,5	-	-	2,97	-	3,56	-
Sendwix 7DF-U / SND-7DF-U	200 mm	64	250 × 200 × 240	12,9	-	-	2,92	-	3,50	-
Sendwix 6DF-U / SND-6DF-U	175 mm	60	248 × 175 × 240	11,5	-	-	2,89	-	3,47	-
Sendwix 5DF-U / SND-5DF-U	150 mm	72	248 × 150 × 240	9,9	-	-	2,83	-	3,40	-
Sendwix 2DF-U / SND-5DF-U	115 mm	196	125 × 115 × 240	4,9	-	-	1,93	-	2,31	-

Nosné preklady



Názov/ Katalógové označenie	Hrúbka steny	Hmot. kg/ks	Rozmer (mm) d x š x v	Balenie ks/pal	Maximálna svetlosť otvoru (mm)	Cena bez DPH/ks	Cena s DPH/ks
Preklad 8DF 1000 / SND-8DF-1000	240 mm	123,8	1000 × 240 × 240	12	700	37,96	45,55
Preklad 8DF 1250 / SND-8DF-1250		154,7	1250 × 240 × 240	12	950	45,66	54,79
Preklad 8DF 1500 / SND-8DF-1500		185,7	1500 × 240 × 240	12	1200	49,74	59,69
Preklad 8DF 1750 / SND-8DF-1750		217,4	1750 × 240 × 240	8	1450	53,36	64,03
Preklad 8DF 2000 / SND-8DF-2000		248,4	2000 × 240 × 240	8	1700	70,48	84,57
Preklad 8DF 2250 / SND-8DF-2250		279,5	2250 × 240 × 240	8	1850	79,99	95,99
Preklad 8DF 2500 / SND-8DF-2500		312,4	2500 × 240 × 240	7	2100	98,80	118,56
Preklad 8DF 2750 / SND-8DF-2750		346,0	2750 × 240 × 240	6	2250	108,43	130,11
Preklad 8DF 3000 / SND-8DF-3000		377,5	3000 × 240 × 240	6	2500	116,36	139,63
Preklad 7DF 1000 / SND-7DF-1000		200 mm	90,4	1000 × 200 × 240	15	700	33,84
Preklad 7DF 1250 / SND-7DF-1250	113,0		1250 × 200 × 240	15	950	40,45	48,53
Preklad 7DF 1500 / SND-7DF-1500	135,6		1500 × 200 × 240	10	1200	49,07	58,89
Preklad 7DF 1750 / SND-7DF-1750	158,2		1750 × 200 × 240	10	1450	51,99	62,38
Preklad 7DF 2000 / SND-7DF-2000	180,8		2000 × 200 × 240	10	1700	66,10	79,32
Preklad 7DF 2250 / SND-7DF-2250	203,4		2250 × 200 × 240	10	1850	74,06	88,87
Preklad 7DF 2500 / SND-7DF-2500	226,0		2500 × 200 × 240	8	2100	83,66	100,40
Preklad 7DF 2750 / SND-7DF-2750	248,6		2750 × 200 × 240	8	2250	93,16	111,79
Preklad 7DF 3000 / SND-7DF-3000	271,2		3000 × 200 × 240	7	2500	100,29	120,35

	Názov/ Katalógové označenie	Hrúbka steny	Hmot. kg/ks	Rozmer (mm) d x š x v	Balenie ks/pal	Maximálna svetlosť otvoru (mm)	Cena bez DPH/ks	Cena s DPH/ks
Nosné preklady 	Preklad 6DF 1000 / SND-6DF-1000	175 mm	79,1	1000 × 175 × 240	15	700	33,20	39,84
	Preklad 6DF 1250 / SND-6DF-1250		98,4	1250 × 175 × 240	15	950	39,31	47,18
	Preklad 6DF 1500 / SND-6DF-1500		118,7	1500 × 175 × 240	15	1200	51,33	61,59
	Preklad 6DF 1750 / SND-6DF-1750		138,3	1750 × 175 × 240	12	1450	54,62	65,54
	Preklad 6DF 2000 / SND-6DF-2000		157,8	2000 × 175 × 240	12	1700	61,18	73,42
	Preklad 6DF 2250 / SND-6DF-2250		178,7	2250 × 175 × 240	10	1850	70,82	84,98
	Preklad 6DF 2500 / SND-6DF-2500		198,4	2500 × 175 × 240	10	2100	77,84	93,40
	Preklad 6DF 2750 / SND-6DF-2750		219,6	2750 × 175 × 240	10	2250	88,14	105,77
	Preklad 6DF 3000 / SND-6DF-3000		239,4	3000 × 175 × 240	8	2500	95,51	114,62
	Preklad 5DF 1000 / SND-5DF-1000	150 mm	63,8	1000 × 150 × 240	18	700	32,34	38,81
	Preklad 5DF 1250 / SND-5DF-1250		79,6	1250 × 150 × 240	18	950	38,30	45,96
	Preklad 5DF 1500 / SND-5DF-1500		95,9	1500 × 150 × 240	18	1200	50,00	59,99
	Preklad 5DF 1750 / SND-5DF-1750		112,0	1750 × 150 × 240	18	1450	53,21	63,85
	Preklad 5DF 2000 / SND-5DF-2000		128,0	2000 × 150 × 240	12	1700	59,63	71,56
	Preklad 5DF 2250 / SND-5DF-2250		145,0	2250 × 150 × 240	12	1850	69,03	82,83
	Preklad 5DF 2500 / SND-5DF-2500		161,0	2500 × 150 × 240	12	2100	75,91	91,09
	Preklad 5DF 2750 / SND-5DF-2750		177,7	2750 × 150 × 240	10	2250	86,00	103,20
	Preklad 5DF 3000 / SND-5DF-3000		193,8	3000 × 150 × 240	10	2500	93,12	111,74
	Preklad 2DF 1000 / SND-2DF-1000	115 mm	48,6	1000 × 115 × 240	32	700	13,26	15,91
	Preklad 2DF 1250 / SND-2DF-1250		60,7	1250 × 115 × 240	32	950	17,57	21,08
	Preklad 2DF 1500 / SND-2DF-1500		73,0	1500 × 115 × 240	24	1200	19,94	23,93
	Preklad 2DF 1750 / SND-2DF-1750		85,7	1750 × 115 × 240	24	1450	25,61	30,73
	Preklad 2DF 2000 / SND-2DF-2000		98,0	2000 × 115 × 240	16	1700	33,99	40,79
	Preklad 2DF 2250 / SND-2DF-2250		111,2	2250 × 115 × 240	16	1850	38,41	46,09
	Preklad 2DF 2500 / SND-2DF-2500		123,5	2500 × 115 × 240	16	2100	48,16	57,79
	Preklad 2DF 2750 / SND-2DF-2750		135,8	2750 × 115 × 240	14	2250	52,69	63,23
	Preklad 2DF 3000 / SND-2DF-3000		148,2	3000 × 115 × 240	14	2500	58,92	70,70
	Licové murivo  	Sendwix licová tehla VF / SND-VF nefarbená ●●	240	290 × 140 × 65	4,7	89 / 44 / 22	314 / 307 / 339	0,47 0,70 ●●
Sendwix licová NF / SND-NF nefarbená ●		308	240 × 115 × 71	3,6	32 / 48 / 96	443 / 413 / 398	0,42 0,60 ●	0,50 0,72 ●
Betónová hlavica								
- hladká / SND-BH-H ●●●●		32	390 x 390	15,7	-	-	-	cena na vyžiadanie
- profilovaná / SND-BH-P ●●●●		32	320 x 245	6,5	-	-	-	cena na vyžiadanie
Betónová strieška								
- hladká / SND-BS-H ●●●●	36	390 x 270	11,3	-	-	-	cena na vyžiadanie	
- profilovaná / SND-BS-P ●●●●	36	497 x 245	9,3	-	-	-	cena na vyžiadanie	
Nástroje a príslušen- stvo 	Zaslepovacie viečko Ø 40 mm / SND-ZV	1 ks	ø 40 mm	-	-	-	0,25	0,30
	Manipulačný hák / SND-MH	1 ks	-	-	-	-	25,00	30,00
	Malé kliešte / SND-MK	1 ks	-	-	-	-	131,00	157,20
	Veľké kliešte / SND-VK	1 ks	-	-	-	-	144,00	172,80
	Bezfarebný prípravok na ochranu Sendwix							
	- 5 litrov / SND-FH5	5 l	-	-	-	-	12,50	15,00
	- 1 liter / SND-FH1	1 l	-	-	-	-	45,00	54,00
	Vykružovacia korunka Ø 82 mm / SND-VKO	1ks	ø 82 mm dĺžka 120mm	-	-	-	140,00	168,00
	Stenová spona / SND-SSP sada = 1ks spona + 2ks Narážacia hmož. s	1 ks	-	-	-	-	1,96	2,35
	Dávkovač na lepidlo * / SND-DL	1 ks	-	-	-	-	90,00	108,00
	Dávk. na lep. s posuvným hradítkom * / SND-	1 ks	-	-	-	-	248,00	297,60
	Vykládka hydraulickou rukou	1 ks					5,00	6,00
	Paleta KM BETA	1 ks	120x80, 100x120	-	-	-	16,00	19,20

Profiblok

- pálené murivo



Murovacie bloky
s lepidlom
na rebrá



Murovacie bloky
s murovacou
penou

Brúsené murivo

V cene je zahrnuté príslušné pojivo (lepidlo / pena)



Názov/ Katalógové označenie	Hrúbka steny	Bal. ks/pal.	Rozmer (mm) d x š x v	Hmot. kg/ks	Spotr. ks/m ²	Spotr. ks/m ³	Z / P			Z / P		
							Cena bez DPH/ks	Cena bez DPH/m ²	Cena bez DPH/m ³	Cena s DPH/ks	Cena s DPH/m ²	Cena s DPH/m ³
Profiblok 440 Brus / PB-440-B-Z(P)	440 mm	60	247 × 440 × 249	21,90	16,0	36,4	5,07	81,12	184,55	6,08	97,34	221,46
Profiblok 400 Brus / PB-400-B-Z(P)	400 mm	72	247 × 400 × 249	18,96	16,0	40,4	4,92	255,05	196,80	5,90	306,06	236,16
Profiblok 365 Brus / PB-365-B-Z(P)	365 mm	72	247 × 365 × 249	18,57	16,0	43,8	4,77	76,32	208,93	5,72	91,58	250,72
Profiblok 300 Brus / PB-300-B-Z(P)	300 mm	96	247 × 300 × 249	13,48	16,0	53,3	3,30	52,80	175,89	3,96	63,36	211,07
Profiblok 300 P15 Brus / PB-300-B-Z(P)-P15		96	247 × 300 × 249	13,48	16,0	53,3	3,52	56,32	187,62	4,22	67,58	225,14
Profiblok 300 1/2 Brus / PB-1/2-300-B-Z(P)		96	125 × 300 × 249	8,27	32,0	106,6	3,07	98,24	327,26	3,68	117,89	392,71
Profiblok 300 1/2 P15 Brus / PB-1/2-300-B-Z(P)-P15		96	125 × 300 × 249	8,27	32,0	106,6	3,30	105,60	351,78	3,96	126,72	422,14
Profiblok 240 Brus / PB-240-B-Z(P)	240 mm	72	372 × 240 × 249	16,16	10,7	44,4	3,90	41,73	173,16	4,68	50,08	207,79
Profiblok 240 P15 Brus / PB-240-B-Z(P)-P15		72	372 × 240 × 249	16,16	10,7	44,4	4,12	44,08	182,93	4,94	52,90	219,52
Profiblok 175 Brus / PB-175-B-Z(P)	175 mm	72	497 × 175 × 249	16,75	8,0	45,7	3,86	30,88	176,40	4,63	37,06	211,68
Profiblok 140 Brus / PB-140-B-Z(P)	140 mm	96	497 × 140 × 249	14,92	8,0	57,1	3,32	26,56	189,90	3,98	31,87	227,88
Profiblok 115 Brus / PB-115-B-Z(P)	115 mm	100	497 × 115 × 249	13,00	8,0	69,6	3,00	24,00	208,80	3,60	28,80	250,56
Profiblok 80 Brus / PB-80-B-Z(P)	80 mm	140	497 × 80 × 249	8,8	8,0	100,0	2,36	18,88	236,00	2,83	22,66	283,20

Murivo na maltu

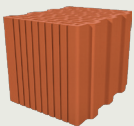

Názov/ Katalógové označenie	Hrúbka steny	Bal. ks/pal.	Rozmer (mm) d x š x v	Hmot. kg/ks	Spotr. ks/m ²	Spotr. ks/m ³	Cena bez DPH/ks	Cena bez DPH/m ²	Cena bez DPH/m ³	Cena s DPH/m ²	Cena s DPH/m ²	Cena s DPH/m ³
Profiblok 440 / PB-440	440 mm	60	247 × 440 × 238	20,90	16,0	36,4	4,22	226,87	516,11	5,06	272,24	619,33
Profiblok 400 / PB-400	400 mm	72	247 × 400 × 238	18,10	16,0	40,0	4,07	210,99	527,47	4,88	253,19	632,96
Profiblok 365 / PB-365	365 mm	72	247 × 365 × 238	17,26	16,0	43,8	3,92	195,69	535,71	4,70	234,83	642,85
Profiblok 300 / PB-300	300 mm	96	247 × 300 × 238	12,79	16,0	53,3	2,64	42,24	140,71	3,17	50,69	168,85
Profiblok 300 Aku / PB-300-AKU		96	247 × 300 × 238	20,20	16	53,3						
Profiblok 300 P15 / PB-300-P15		96	247 × 300 × 238	12,79	16,0	53,3	2,86	45,76	152,44	3,43	54,91	182,93
Profiblok 300 1/2 / PB-1/2-300		96	125 × 300 × 238	8,00	32,0	53,3	2,41	77,12	256,91	2,89	92,54	308,29
Profiblok 300 1/2 P15 / PB-1/2-300-P15	96	125 × 300 × 238	8,00	32,0	106,6	2,64	84,48	281,42	3,17	101,38	337,70	
Profiblok 240 / PB-240	240 mm	72	372 × 240 × 238	15,30	10,7	44,4	3,06	32,74	135,86	3,67	39,29	163,03
Profiblok 240 P15 / PB-240-P15		72	372 × 240 × 238	15,30	10,7	44,4	3,29	35,20	146,08	3,95	42,24	175,30
Profiblok 175 / PB-175	175 mm	64	497 × 175 × 238	15,93	8,0	45,7	3,25	26,00	148,53	3,90	31,20	178,24
Profiblok 140 / PB-140	140 mm	80	497 × 140 × 249	14,25	8,0	57,1	2,96	23,68	169,31	3,55	28,42	203,17
Profiblok priečkovka 290 / PB-290		390	290 × 140 × 65	2,07	44 / 22	339 / 314	0,55	-	-	0,66	-	-
Profiblok tehla plná odlahčená VF / PB-VF		195	290 × 140 × 65	3,11	89 / 44	314 / 307	0,84	36,96	263,76	1,01	44,35	316,51
Profiblok 115 / PB-115	115 mm	96	497 × 115 × 238	12,47	8,0	69,6	2,45	19,60	170,52	2,94	23,52	204,62
Profiblok 115 AKU / PB-115-AKU		96	497 × 115 × 238	14,26	8,0	69,6	3,16	25,28	219,94	3,79	30,34	263,93
Profiblok tehla plná odlahčená NF / PB-NF		364	240 × 115 × 71	2,78	96 / 47	413 / 398	0,69	33,12	284,97	0,83	39,74	341,96
Profiblok 80 / PB-80	80 mm	96	497 × 80 × 238	8,53	8,0	100,0	1,95	15,60	195,00	2,34	18,72	234,00

Vencovky

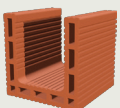

Profiblok vencovka 365 / PB-V365	365 mm	72	240 × 365 × 238	9,80	8,0	43,8	4,51	-	-	5,41	-
Profiblok vencovka 300 / PB-V300	300 mm	96	240 × 300 × 238	8,17	32,0	53,3	3,58	-	-	4,30	-
Profiblok vencovka 240 / PB-V240	240 mm	96	240 × 240 × 238	8,01	10,7	44,4	2,90	-	-	3,48	-
Profiblok vencovka 175 / PB-V175	175 mm	144	240 × 175 × 238	7,25	8,0	45,7	2,16	-	-	2,59	-

Stropné systémy

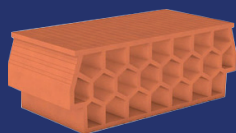

Miako

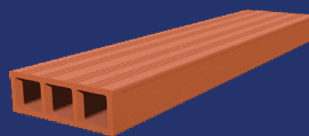

Hurdis

	Názov/ Katalógové označenie	Počet ks / pal	Hmot. kg/ks	Rozmer (mm) d x š x v	Cena bez DPH/ks	Cena s DPH/ks
Stropné vložky	Miako 15 / 62,5 / SM-150	80	14,3	250 × 525 × 150	2,80	3,36
	Miako 19 / 62,5 / SM-190	64	16,4	250 × 525 × 190	3,40	4,08

	Názov/ Katalógové označenie	Počet ks / pal	Hmot. kg/ks	Rozmer (mm) d x š x v	Cena bez DPH/ks	Cena s DPH/ks
Stropné vložky	Hurdis 1 rovné čelo / SH-RC	60	17,1	980 × 250 × 80	8,29	9,95
	Hurdis 2 šikmé čelo / SH-SC	60	16,8	1000 × 250 × 80	8,29	9,95

	Názov/ Katalógové označenie	Počet ks / pal	Hmot. kg/ks	Rozmer (mm) d x š x v	Cena bez DPH/ks	Cena s DPH/ks
Stropné nosníky	Stropný nosník MIAKO / SM-N-1750		38,9	1750 × 160 × 189	20,00	24,00
	Stropný nosník MIAKO / SM-N-2000		44,4	2000 × 160 × 189	22,00	26,40
	Stropný nosník MIAKO / SM-N-2250		50,0	2250 × 160 × 189	25,00	30,00
	Stropný nosník MIAKO / SM-N-2500		55,5	2500 × 160 × 189	28,00	33,60
	Stropný nosník MIAKO / SM-N-2750		61,1	2750 × 160 × 189	30,00	36,00
	Stropný nosník MIAKO / SM-N-3000		66,6	3000 × 160 × 189	37,00	44,40
	Stropný nosník MIAKO / SM-N-3250		72,2	3250 × 160 × 189	40,00	48,00
	Stropný nosník MIAKO / SM-N-3500		79,4	3500 × 160 × 189	43,00	51,60
	Stropný nosník MIAKO / SM-N-3750		85,1	3750 × 160 × 189	46,00	55,20
	Stropný nosník MIAKO / SM-N-4000		90,7	4000 × 160 × 189	54,00	64,80
	Stropný nosník MIAKO / SM-N-4250		98,8	4250 × 160 × 189	58,00	69,60
	Stropný nosník MIAKO / SM-N-4500		104,6	4500 × 160 × 189	63,00	75,60
	Stropný nosník MIAKO / SM-N-4750		110,5	4750 × 160 × 189	67,00	80,40
	Stropný nosník MIAKO / SM-N-5000		121,0	5000 × 160 × 189	73,00	87,60
	Stropný nosník MIAKO / SM-N-5250		127,0	5250 × 160 × 189	79,00	94,80
	Stropný nosník MIAKO / SM-N-5500		133,1	5500 × 160 × 189	83,00	99,60
	Stropný nosník MIAKO / SM-N-5750		141,5	5750 × 160 × 189	87,00	104,40
	Stropný nosník MIAKO / SM-N-6000		150,8	6000 × 160 × 189	97,00	116,40
	Stropný nosník MIAKO / SM-N-6250		161,6	6250 × 160 × 189	101,00	121,20
	Stropný nosník MIAKO / SM-N-6500		168,1	6500 × 160 × 189	115,00	138,00
	Stropný nosník MIAKO / SM-N-6750		174,5	6750 × 160 × 189	123,00	147,60
	Stropný nosník MIAKO / SM-N-7000		181,0	7000 × 160 × 189	134,00	160,80
	Stropný nosník MIAKO / SM-N-7250		187,5	7250 × 160 × 189	137,00	164,40
	Stropný nosník MIAKO / SM-N-7500		197,2	7500 × 160 × 189	výroba na objednávku	
	Stropný nosník MIAKO / SM-N-7750		203,8	7750 × 160 × 189	výroba na objednávku	
	Stropný nosník MIAKO / SM-N-8000		210,4	8000 × 160 × 189	výroba na objednávku	
	Stropný nosník MIAKO / SM-N-8250		217,0	8250 × 160 × 189	výroba na objednávku	

	Názov/ Katalógové označenie	Počet ks / pal	Hmot. kg/ks	Rozmer (mm) d x š x v	Cena bez DPH/ks	Cena s DPH/ks
Stropné nosníky	Stropný nosník HURDIS 2 na šikmé čelo / SH-N-1750		61,2	1750 × 255 × 237	20,11	24,14
	Stropný nosník HURDIS 2 na šikmé čelo / SH-N-2000		69,9	2000 × 255 × 237	22,60	27,12
	Stropný nosník HURDIS 2 na šikmé čelo / SH-N-2250		78,7	2250 × 255 × 237	25,50	30,59
	Stropný nosník HURDIS 2 na šikmé čelo / SH-N-2500		87,4	2500 × 255 × 237	28,42	34,10
	Stropný nosník HURDIS 2 na šikmé čelo / SH-N-2750		97,4	2750 × 255 × 237	31,33	37,59
	Stropný nosník HURDIS 2 na šikmé čelo / SH-N-3000		106,3	3000 × 255 × 237	38,46	46,15
	Stropný nosník HURDIS 2 na šikmé čelo / SH-N-3250		117,0	3250 × 255 × 237	41,64	49,97
	Stropný nosník HURDIS 2 na šikmé čelo / SH-N-3500		126,0	3500 × 255 × 237	44,90	53,88
	Stropný nosník HURDIS 2 na šikmé čelo / SH-N-3750		137,5	3750 × 255 × 237	48,07	57,68
	Stropný nosník HURDIS 2 na šikmé čelo / SH-N-4000		146,7	4000 × 255 × 237	55,92	67,11
	Stropný nosník HURDIS 2 na šikmé čelo / SH-N-4250		155,9	4250 × 255 × 237	60,34	72,41
	Stropný nosník HURDIS 2 na šikmé čelo / SH-N-4500		165,0	4500 × 255 × 237	65,29	78,34
	Stropný nosník HURDIS 2 na šikmé čelo / SH-N-4750		175,3	4750 × 255 × 237	70,31	84,37
	Stropný nosník HURDIS 2 na šikmé čelo / SH-N-5000		186,6	5000 × 255 × 237	76,20	91,44
	Stropný nosník HURDIS 2 na šikmé čelo / SH-N-5250		197,4	5250 × 255 × 237	82,57	99,08
	Stropný nosník HURDIS 2 na šikmé čelo / SH-N-5500		208,7	5500 × 255 × 237	86,27	103,53
	Stropný nosník HURDIS 2 na šikmé čelo / SH-N-5750		220,4	5750 × 255 × 237	90,69	108,83
	Stropný nosník HURDIS 2 na šikmé čelo / SH-N-6000		232,6	6000 × 255 × 237	101,11	121,33
	Stropný nosník HURDIS 2 na šikmé čelo / SH-N-6250		245,4	6250 × 255 × 237	105,33	126,39
	Stropný nosník HURDIS 2 na šikmé čelo / SH-N-6500		253,5	6500 × 255 × 287	120,16	144,20
	Stropný nosník HURDIS 2 na šikmé čelo / SH-N-6750		263,2	6750 × 255 × 287	128,79	154,55
	Stropný nosník HURDIS 2 na šikmé čelo / SH-N-7000		276,5	7000 × 255 × 287	140,27	168,32
	Stropný nosník HURDIS 2 na šikmé čelo / SH-N-7250		286,3	7250 × 255 × 287	143,81	172,57

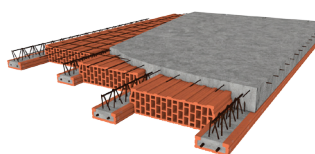

Stropný systém MIAKO

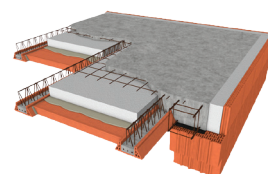

Stropný systém HURDIS

		Názov	Katalog. označenie	Objem/ml	Výdatnosť 1 dózy na tehlové murivo / m ² (šírka muríva 175 -440 mm)			Výdatnosť 1 dózy na tehlové mur. / m ² (šírka muríva 80 - 440 mm)		Cena bez DPH/ ks	Cena s DPH/ks
Pena		Murovacíá Pena	ZP	750 ml	5,5			11		13,41	16,09
		Názov	Katalog. označenie	Zrornosť	Dop. hrúbka vrstvy (mm)	Balenie vreće (kg)	Balenie pal / ks	Spotreba pri dop. hrúbke (kg/m ²)	Cena bez DPH/t	Cena bez DPH/ bal	Cena s DPH/bal
Murovacíe malty (brúsené pálené murívo Profiblok)		Zakladacia malta pre pálené murivo a pórobeton (10 N/mm ²)	ZM-910	4,0	10	25	48	17,6	260	6,50	7,80
		- so zimnou úpravou ❄️	ZM-910-Z	4,0	10	25	48	17,6	283	7,08	8,49
		Lepidlo celoplošné (10 N/mm ²)	ZM-911	0,7	3	25	48	3,7	580	14,50	17,40
		- so zimnou úpravou ❄️	ZM-911-Z	0,7	3	25	48	3,7	603	15,08	18,09
		Lepidlo na rebrá (10 N/mm ²)	ZM-912	0,7	1	25	48	1,4	330	8,25	9,90
		- so zimnou úpravou ❄️	ZM-912-Z	0,7	1	25	48	1,4	353	8,83	10,59
Murovacíe malty (Profiblok na maltu a betónové tvárnice)		Murovacíá cementová malta (10 N/mm ²)	ZM-901	4,0	12	25	48	21,0	145	3,63	4,35
		- so zimnou úpravou ❄️	ZM-901-Z	4,0	12	25	48	21,0	168	4,20	5,04
		- jemná	ZM-901j	2,0	12	25	48	28,1	150	3,75	4,50
		- jemná so zimnou úpravou ❄️	ZM-901j-Z	2,0	12	25	48	28,1	173	4,33	5,19
		Murovacíá cementová malta (15 N/mm ²)	ZM-902	4,0	12	40	30	22,0	195	7,80	9,36
		- so zimnou úpravou ❄️	ZM-902-Z	4,0	12	40	30	22,0	218	8,72	10,46
Murovacíe malty (Sendwix a betónové bloky)		Murovacíá malta vápenocementová (5 N/mm ²)	ZM-903	4,0	12	40	30	21,0	135	5,40	6,48
		- jemná	ZM-903j	2,0	12	40	30	22,0	141	5,64	6,77
		Tepelnoizolačná murovacíá malta λ = 0,21 W/(m.K)	TM-501	2,0	12	40 l	40	13,8 l/m ²		14,00	16,80
		- so zimnou úpravou ❄️	TM-501-Z	2,0	12	40 l	40	13,8 l/m ²		16,20	19,44
		Murovacíá malta na vápenopieskové a betónové bloky (20 N/mm ²)	ZM-920	4,0	12	25	48	21,7	320	8,00	9,60
		- so zimnou úpravou ❄️	ZM-920-Z	4,0	12	25	48	21,7	343	8,58	10,29
Murovacíe malty (Pohľadové murívo)		Lepidlo na Sendwix a betónové bloky (10 N/mm ²)	ZM-921	1,2	2	25	48	2,6	345	8,63	10,36
		- so zimnou úpravou ❄️	ZM-921-Z	1,2	2	25	48	2,6	368	9,20	11,04
		- biele *	ZM-921-B	1,2	2	25	48	2,6	380	9,50	11,40
		Murovacíá a škárovacia malta pre lícové murívo (10 N/mm ²)	ZM-907	2,0	12	25	48	18,7	270	6,75	8,10
	Škárovacia malta pre lícové murívo (5 N/mm ²)	ZM-908	0,7	10	25	48	16,0	260	6,50	7,80	
Murovacíe malty (Pórobeton)		Zakladacia malta (10 N/mm ²)	ZM-910	4,0	10	25	48	17,6	260	6,50	7,80
		- so zimnou úpravou ❄️	ZM-910-Z	4,0	10	25	48	17,6	283	7,08	8,49
		Murovacíá malta na pórobeton (5 N/mm ²)	ZM-906	0,7	2	25	48	2,6	270	6,75	8,10
		- so zimnou úpravou ❄️	ZM-906-Z	0,7	2	25	48	2,6	293	7,33	8,79
Murovacíe malty (Univerzálné)		Univerzálna murovacíá a omietková malta (2,5 N/mm ²)									
		- vreće 25 kg	ZM-904	2,0	12 murov. / 15 omiet.	25	48	18 murov. / 22,5 omietanie	150	3,75	4,50
		- vreće 40 kg	ZM-904-40	2,0	12 murov. / 15 omiet.	40	30	18 murov. / 22,5 omietanie	145	5,80	6,96
	Vápenná murovacíá malta	ZM-909	1,2	10	25	48	17,6	160	4,00	4,80	
Stierky a potery (podlahy)		Cementový poter (20 N/mm ²)									
		- vreće 25 kg	CP-101	4,0	10 - 50	25	48	18,5 - 92,5	145	3,63	4,35
		- so zimnou úpravou ❄️	CP-101-Z	4,0	10 - 50	25	48	18,5 - 92,5	163	4,08	4,89
		- jemný	CP-101j	1,2	5 - 15	25	48	8,5 - 25,5	215	5,38	6,45
		- jemný so zimnou úpravou ❄️	CP-101j-Z	1,2	5 - 15	25	48	8,5 - 25,5	233	5,83	6,99
		vreće 40 kg	CP-101-40	4,0	10 - 50	40	30	18,5 - 92,5	140	5,60	6,72
		- so zimnou úpravou ❄️	CP-101-Z-40	4,0	10 - 50	40	30	18,5 - 92,5	158	6,32	7,58
		- jemný	CP-101j-40	1,2	5 - 15	40	30	8,5 - 25,5	210	8,40	10,08
	- jemný so zimnou úpravou ❄️	CP-101j-Z-40	1,2	5 - 15	40	30	8,5 - 25,5	228	9,12	10,94	

Je možné murovať aj v zimnom období? Stavebnú sezónu môžete predĺžiť aj o zimné mesiace vďaka našej malte so zimnou úpravou. Murovať môžete aj pri teplotách - 5 °C. A ako spoznáte maltu so zimnou úpravou? Veľmi ľahko, od ostatných sa odlišuje písmenom „Z“ uvedenom v katalógovom označení. V cenníku je označená symbolom ❄️

	Názov		Zrornosť	Dop. hrúbka vrstvy (mm)	Balenie vrece (kg)	Balenie pal / ks	Spotreba pri dop. hrúbke (kg/m ²)	Cena bez DPH/t	Cena bez DPH/ bal	Cena s DPH/bal
Stierky a potery (podlahy)	Cementový poter (25 N/mm ²)									
	- vrece 25 kg	CP-102	4,0	10 - 50	25	48	18,5 - 92,5	150	3,75	4,50
	- so zimnou úpravou ❄️	CP-102-Z	4,0	10 - 50	25	48	18,5 - 92,5	168	4,20	5,04
	- jemný	CP-102j	1,2	5 - 15	25	48	8,5 - 25,5	247	6,18	7,41
	- jemný so zimnou úpravou ❄️	CP-102j-Z	1,2	5 - 15	25	48	8,5 - 25,5	265	6,63	7,95
	- vrece 40 kg	CP-102-40	4,0	10 - 50	40	30	18,5 - 92,5	145	5,80	6,96
	- so zimnou úpravou ❄️	CP-102-Z-40	4,0	10 - 50	40	30	18,5 - 92,5	163	6,52	7,82
	- jemný	CP-102j-40	1,2	5 - 15	40	30	8,5 - 25,5	242	9,68	11,62
	- jemný so zimnou úpravou ❄️	CP-102j-Z-40	1,2	5 - 15	40	30	8,5 - 25,5	260	10,40	12,48
	Cementový poter (30 N/ mm ²)									
	- vrece 25 kg	CP-103	4,0	10 - 50	25	48	18,5 - 92,5	160	4,00	4,80
	- so zimnou úpravou ❄️			10 - 50	25	48	18,5 - 92,5	178	4,45	5,34
	- vrece 40 kg	CP-103-40	4,0	10 - 50	40	30	18,5 - 92,5	155	6,20	7,44
	- so zimnou úpravou ❄️	CP-103-Z	4,0	10 - 50	40	30	18,5 - 92,5	173	6,92	8,30
Špeciálny poter pre spádové podlahové konštrukcie	CP-107	4,0	5 - 100	25	48	9,7 - 195,0	290	7,25	8,70	
Samonivelizačná polymércementová stierka (25 N/mm ²)	CP-111	0,7	5	25	48	7,0	835	20,88	25,05	
Samonivelizačná sádrová stierka (25 N/mm ²)	SP-115	0,7	5	25	48	7,5	515	12,88	15,45	
Samonivelizačný sádrový poter (20 N/mm ²)	SP-120	2,0	25 - 40	25	48	46,0 - 74,6	205	5,13	6,15	
Betónové zmesi	Betón B 30 (30 N/mm ²) C25/30	BS-130	4,0	10 - 50	25	48	18,5 - 55,5	165	4,13	4,95
	Rýchlortvrdnúca suchá betónová zmes	BS-131	4,0	10	25	48	20,0	215	5,38	6,45
	Opravný betón (čiastočne samorozlivový)	BS-132	4,0	10 - 30	25	48	18,5 - 55,5	355	8,88	10,65
Piesok	Kremičitý piesok	KP-401	2,0	-	25	48	-	205	5,13	6,15
Omietyky a fasády (príprava podkladu)	Cementový postrek	OM-201	4,0	max. 3	40	30	5,2	207	8,28	9,94
	Podkladový spojovací mostík	OM-209	0,4	0,5	25	48	1,0	608	18,24	21,89
	Penetrácia základná	PZ	-	-	5 l	-	0,1 - 0,2		12,30	14,76
Omietyky a fasády (jadrové)	Jadrová omiетка vápenocementová strojová									
	- vrece 25 kg	OM-202	1,2	max. 15 *	25	48	11,6	170	4,25	5,10
	- vrece 40 kg	OM-202-40	1,2	max. 15 *	40	30	11,6	165	6,60	7,92
	Jadrová omiетка vápenocementová strojová jemná									
	- vrece 25 kg	OM-202j	0,7	max. 10 *	25	48	12,1	185	4,63	5,55
	- vrece 40 kg	OM-202j-40	0,7	max. 10 *	40	30	12,1	180	7,20	8,64
	Jadrová omiетка vápenocementová ručná									
	- vrece 25 kg	OM-203	2,0	max. 20 *	25	48	13,5	165	4,13	4,95
	- vrece 40 kg	OM-203-40	2,0	max. 20 *	40	30	13,5	160	6,40	7,68
	Jadrová omiетка vápenocementová ručná hrubá									
	- vrece 25 kg	OM-203h	4,0	max. 25 *	25	48	14,8	167	4,18	5,01
	- vrece 40 kg	OM-203h-40	4,0	max. 25 *	40	30	14,8	162	6,48	7,78
	Jadrová omiетка vápenocementová ručná jemná									
	- vrece 25 kg	OM-203-j	1,2	max. 15 *	25	48	13,6	200	5,00	6,00
	- vrece 40 kg	OM-203j-40	1,2	max. 15 *	40	30	13,6	190	7,60	9,12
	Jadrová omiетка vápenná	OM-204	2,0	max. 10 *	25	48	12,7	225	5,63	6,75
	Tepelnoizolačná omiетка λ = 0,12 W/(m.K)	TO-502	2,0	30	19 l	42	26,0 l/m ²		16,20	19,44
Omietková zmes na opravu trhlín	OM-210	1,2	3	25	48	3,8	490	12,25	14,70	
Opravná malta na omietyky	OM-211	2,0	10	25	48	12,8	420	10,50	12,60	
Špeciálna cementová malta na opravy (reprofiláciu) betónu a betónových dielcov										
- hrubá	OM-212	1,3	3 - 35	25	48	6 - 70	750	18,75	22,50	
- jemná	OM-212j	2,0	3 - 35	25	48	6 - 70	800	20,00	24,00	

*Dodacie lehoty je 30 dní od dňa potvrdenia objednávky, požadovaný minimálny odber bude upresnený v názkade vzájomnej dohody.

❄️ Zimná úprava

	Názov	Katalógové označenie	Zrnitosť	Doporučená hrúbka vrstvy (mm)	Balenie vrece (kg)	Balenie pal / ks	Spotreba pri doporučenej hrúbke (kg/m ²)	Cena bez DPH/t	Cena bez DPH/ bal	Cena s DPH/bal
Omiety a fasády (štukové)	Vnútrotná štuková omiетка vápenná	JM-301	0,7	max. 3	30	40	3,8	240	7,20	8,64
	- jemná	JM-301j	0,4	max. 2	30	40	2,5	245	7,35	8,82
	Vonkajšia štuková omiетка vápenocementová	JM-302	0,7	max. 2	30	40	3,7	255	7,65	9,18
	- jemná	JM-302j	0,4	max. 3	30	40	2,4	260	7,80	9,36
	Jednovrstvá omiетка ručná a strojová vápenocementová	JM-303	0,7	10	25	48	13,0	150	3,75	4,50
Jednovrstvová zatieraná omiетка	JM-304	0,7	max. 3	40	30	3,8	345	13,80	16,56	
Omiety a fasády (odvlhčovacie)	Jadrová sanačná odvlhčovacia omiетка	OS-401	4,0	min. 25	30	42	30,0	645	19,35	23,22
	Jemná sanačná odvlhčovacia omiетка	OS-402	0,7	min. 2,5	30	42	3,0	655	19,65	23,58
Lepidlá	Lepidlo štandard - C1T	LM-702	0,7	3-4 / 6-8 / 8-12 *	25	48	1,5-2,0/3-4/4-6	205	5,13	6,15
	Lepidlo klasik - C1TE	LM-703	0,7	3-4 / 6-8 / 8-12 *	25	48	1,5-2,0/3-4/4-6	305	7,63	9,15
	Lepidlo - C2T	LM-704	0,7	3-4 / 6-8 / 8-12 *	25	48	1,5-2,0/3-4/4-6	420	10,50	12,60
	Lepidlo super - C2TE	LM-705	0,7	3-4 / 6-8 / 8-12 *	25	48	1,5-2,0/3-4/4-6	435	10,88	13,05
	Lepidlo extraflex - C2TES1	LM-706	0,7	3-4 / 6-8 / 8-12 *	25	48	1,5-2,0/3-4/4-6	540	13,50	16,20
	Lepidlo rýchlotuhnúce - C1FT	LM-707	0,7	3-4 / 6-8 / 8-12 *	25	48	1,5-2,0/3-4/4-6	815	20,38	24,45
	Lepidlo na mozaiku - C1T	LM-708	0,7	3-4 / 6-8 / 8-12 *	25	48	1,5-2,0/3-4/4-6	420	10,50	12,60
	Lepidlo na mozaiku biele ** - C1T	LM-708-B	0,7	3-4 / 6-8 / 8-12 *	25	48	1,5-2,0/3-4/4-6	490	12,25	14,70
	Lepidlo super flex s odolnosťou proti výkvetom - C2TES1	LM-709	0,7	3-4 / 6-8 / 8-12 *	25	48	1,5-2,0/3-4/4-6	660	16,50	19,80
Fasádne stierky	Lepiaci a stierkováci hmot ETAG 004	LM-710	0,7	3-6	25	48	3,0 - 6,0	420	10,50	12,60
	- jemná	LM-710j	0,4	3-6	25	48	3,0 - 6,0	430	10,75	12,90
	Lepidlo univerzál	LM-711	0,7	lepenie dlažby: 3-4 / 6-8 / 8-12 lepenie izolantu a stierkovanie: 3-6	25	48	lepenie dlažby: 1,5-2,0/3-4/4-6 lepenie izolantu a stierkovanie: 3-6	315	7,88	9,45
Palety a služby	Názov		mj.				Cena bez DPH/ mj.	Cena s DPH/ mj.		
	Paleta KM BETA		1 ks				16,00	19,20		
	Vykládka hydraulickou rukou		1 ks				5,00	6,00		

*Doporučená hrúbka vrstvy predstavuje výšku zúbku zubového hľadidla.

**Dodacia lehota je 30 dní odo dňa potvrdenia objednávky, požadovaný minimálny odber bude upresnený na základe vzájomnej dohody.

SP 120 - Samonivelizačný sádrový poter

Vhodný na podlahové vykurovanie

Pochôdzny už po 24 hod.

Po realizácii nie je sprašný

Ideálne rovný

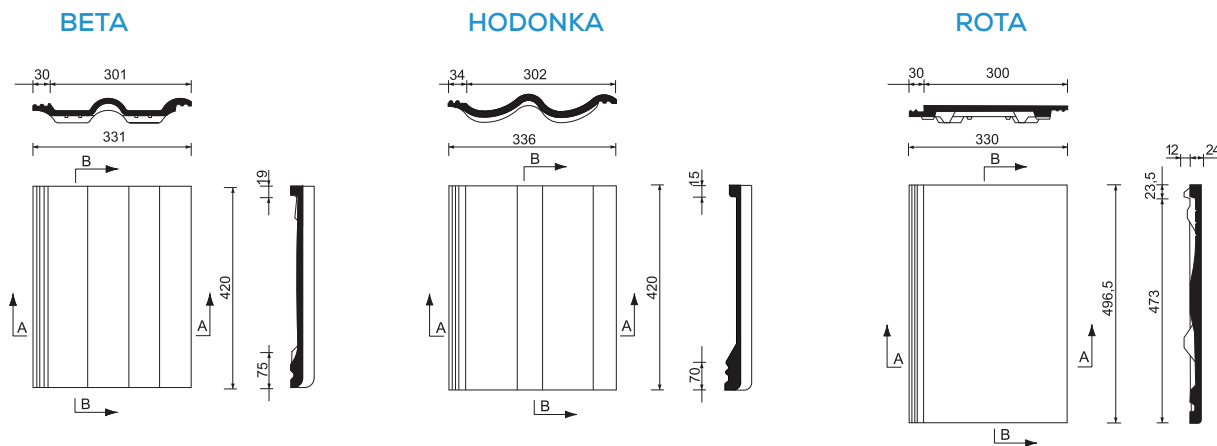

VLASTNOSTI	BETA	HODONKA	ROTA
Rozstup lát pri sklone strechy:	12-22° 320-325 mm 22-30° 320-330 mm > 30° 320-340 mm	12-22° 320-325 mm 22-30° 320-330 mm > 30° 320-340 mm	15-25° 396-402 mm 25-30° 396-406 mm > 30° 396-416 mm

VLASTNOSTI	BETA	HODONKA	ROTA	VLASTNOSTI	BETA	HODONKA	ROTA
Bezpečný sklon krytiny (°)	22	22	25	Dĺžka prvku (mm)	420	420	496,5
Rozmer lát (mm)	40/60 (dopor.)	40/60 (dopor.)	40/60	Šírka prvku (mm)	331	336	330
Plošná hmotnosť (kg/m ²)	42,5	42,5	50,4	Hrúbka prvku (mm)	12	12	25
Hmotnosť (kg/ks)	4,25	4,25	6,3	Nasiakavosť (%)	max. 9	max. 9	max. 9
Objemová hmotnosť (kg/m ³)	2250	2250	2250	Únosnosť (N)	2000	2000	1200
Spotreba (ks/m ²)	10	10	8	Mrazuvzdornosť (cykly)	25	25	25
Trieda reakcie na oheň	A1 - nehorľavé	A1 - nehorľavé	A1 - nehorľavé	Krycia šírka (mm)	301	302	300
Výška vlny (mm)	26	33,5	-	Krycia dĺžka (mm)	320 - 340	320 - 340	396 - 416
Počet vln	2	2	-	Sklon strechy (°)	12-90	12-90	15-90
Norma	ČSN EN 490	ČSN EN 490	ČSN EN 490	Závesná dĺžka (mm)	401	405	473

AKUSTIKA SENDWIX

Pri realizácii akustických deliacich stien sú vhodné murovacie prvky SENDWIX 16DF-LP, 8DF-LP AKU, 14DF-LP, 7DF-LP, 5DF-LP

Výrobok	Hrúbka steny (mm)	Stena s omietkou vážená laboratórná nepriežvučnosť Rw (dB)
8DF-LP AKU	240	57
7DF-LP	200	54
5DF-LP	240	55
5DF-LP	290	56

Výpočet potreby 1 vreca lepidla ZM 921 - Lepidlo na Sendwix a betonové bloky (25 kg), na počet kusov výrobkov SENDWIX:

SENDWIX 16DF-LDE	50 ks	SENDWIX 6DF-LDE	131 ks	SENDWIX 14DF-LP	57 ks
SENDWIX 12DF-LDE	65 ks	SENDWIX 5DF-LP	67 ks	SENDWIX 14DF-LDE	57 ks
SENDWIX 8DF-LDE	100 ks	SENDWIX 4DF-LDE	208 ks	SENDWIX 7DF-LP	114 ks
SENDWIX 8DF-LP AKU	100 ks	SENDWIX 2DF-LD	103 ks	SENDWIX 7DF-LDE	114 ks

Skladba prekladov PROFIBLOK

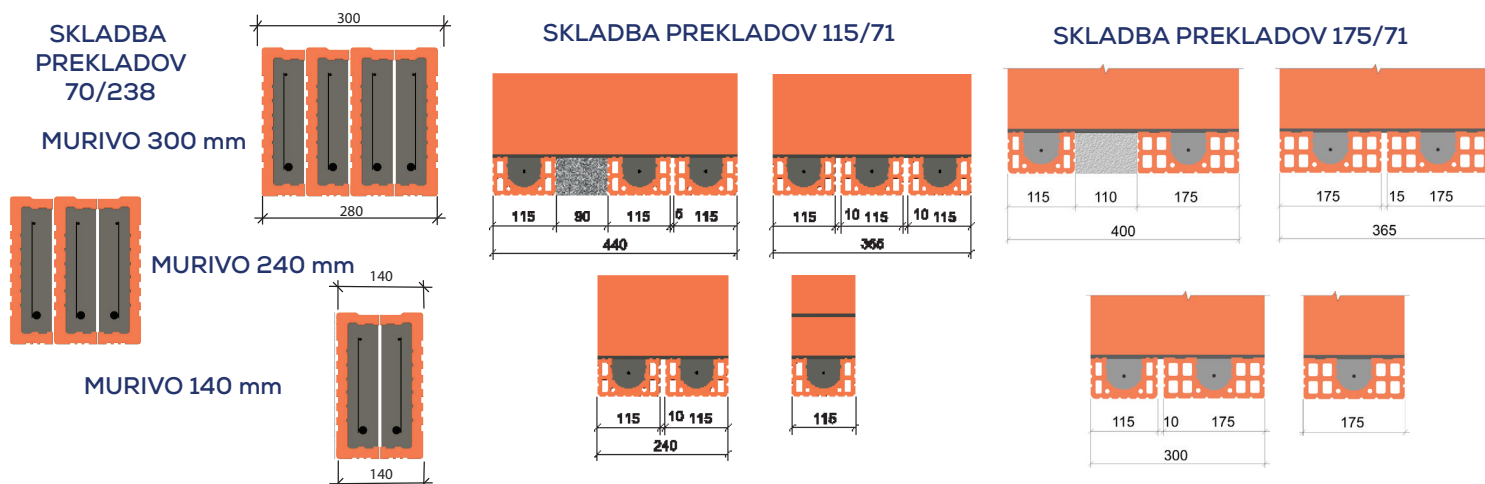

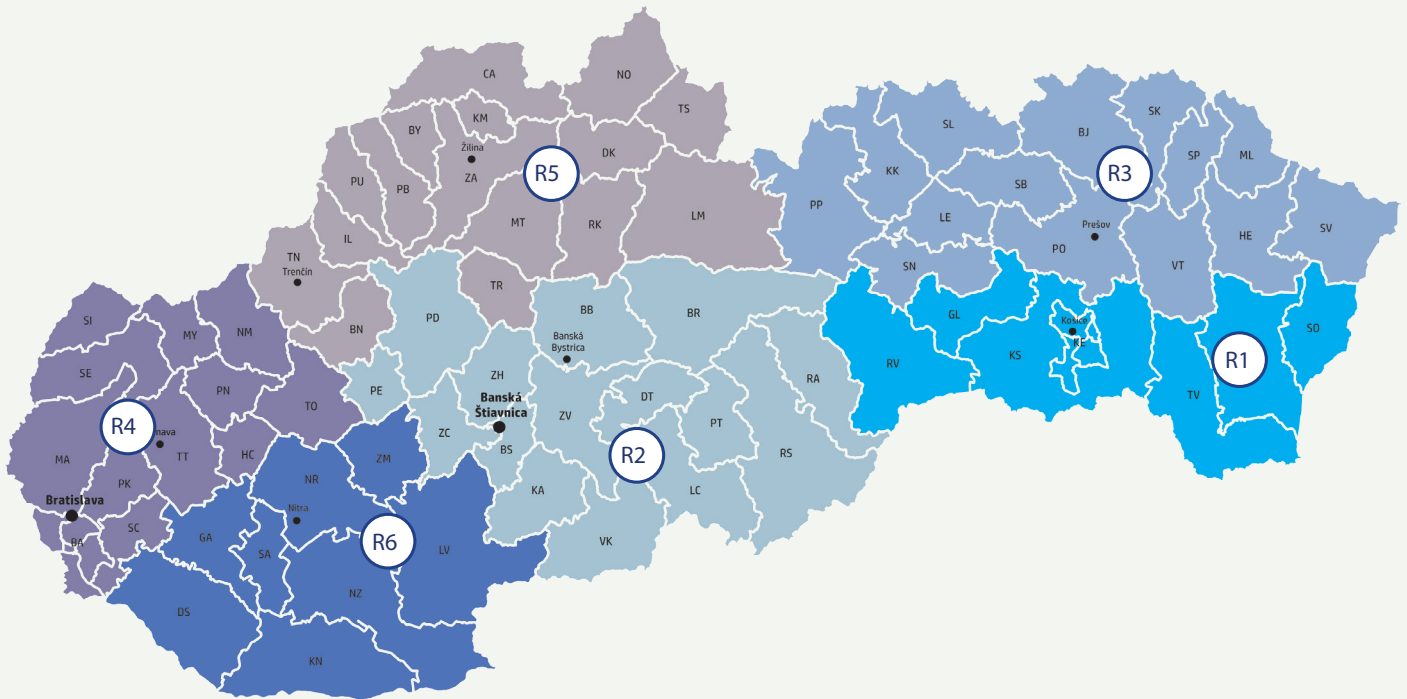

R1	r1@km-beta.sk	+421 903 726 606 RV, GL, KS, KE, TV, MI, SO
R2	r2@km-beta.sk	+421 903 726 606 BS, KA, VK, LC, DT, RS, RA, PT, BR, BB, ZV, PD, ZH, ZC, PE
R3	r3@km-beta.sk	+421 911 950 405 PP, KK, SL, LE, SB, BJ, PO, SK, SP, VT, ML, HE, SV, SN
R4	r4@km-beta.sk	+421 903 726 605 BA, SC, PK, MA, TT, SE, SI, MY, PN, HC, NM, TO
R5	r5@km-beta.sk	+421 911 950 405 ZA, TR, MT, RK, LM, TS, DK, NO, CA, KM, BY, PB, PU, TN, IL, BN
R6	r6@km-beta.sk	+421 911 726 605 NR, ZM, LV, NZ, SA, GA, KN, DS

KM BETA, spol.s r.o.

Križovatka 25/921, 969 01 Banská Štiavnica

Tel.: 045 / 290 90 08, Fax: 045 / 290 90 07

E-mail: kmbeta@kmbeta.sk, info@kmbeta.sk

E-mail objednávky: objednavky@kmbeta.sk

E-mail výpočty: vypocty@kmbeta.sk

Ceny sú uvedené s 20% DPH.

Zmeny technických údajov sú vyhradené. Vyobrazenia výrobkov sú ilustračné.

Toto vydanie ruší platnosť všetkých predchádzajúcich vydání. Tlačové chyby sú vyhradené. Všetky obchodné vzťahy sa riadia platnými Všeobecnými obchodnými a dodacími podmienkami spoločnosti KM BETA, spol. s.r.o..

2. vydanie